



Passerini

Índice

1 Multiuso

2 Sapateiras

4 Cabides

6 Carrinhos

8 Lavanderia

12 Cantoneiras

14 Porta Toalhas

16 Banheiro

26 Organização

30 Fruteiras

33 Suporte de Temperos

36 Kitchen Set

38 Cozinha e Acessórios

46 Cozinha Escorredores

CLIQUE EM UMA DAS CATEGORIAS ACIMA 

DIFERENCIAÇÃO

- Preço • Atendimento Especial
- Entrega Rápida

Sabemos que a diferenciação deve ir além do produto. Por isso, estamos sempre aprimorando os processos e equipe para oferecer o melhor também aos nossos clientes. Preço competitivo, atendimento focado em soluções conjuntas e entrega rápida.

Essa é a melhor maneira de agradecermos a parceria e estar cada vez mais próximo dos nossos clientes.

SUSTENTABILIDADE

O Aço é um material 100% reciclável, reciclado em larga escala no Brasil. Nosso processo de cromeação conta com tratamento de efluentes, evitando a contaminação do solo. A água da estação de tratamento é totalmente reutilizada pela Passerini. As impurezas do ar são filtradas pelos lavadores de gases. Esse é o nosso compromisso com o planeta.

Informações sobre o catálogo:

As dimensões estão expressas em cm, da seguinte forma:

comprimento →

Dimensões (cm)		
32	22,7	35,5

 ← altura

↑
largura

CAIXA ORGANIZADORA MULTIUSO **LAMINADA**



Versátil
banheiro ou lavanderia



Botão descarga
livre



+ Armazenamento
4 ganchos laterais

1594-5 | Cromada cx. c/ 6 pçs



solapa



1595-2 | Black cx. c/ 6 pçs



Código	EAN	Descrição	Dimensão (cm)	Peso (kg)	Qt. cx. master	Dimensão cx. master (cm)	Peso cx. master (kg)	Cubagem cx. master (m³)	DUN 14
1594-5	7897089815945	CAIXA ORGANIZADORA MULTIUSO - CROMADA	39,5 X 16 X 19,5	0,618	6	47 X 34 X 48,5	3,860	0,078	17897089815942
1595-2	7897089815952	CAIXA ORGANIZADORA MULTIUSO - BLACK	39,5 X 16 X 19,5	0,618	6	47 X 34 X 48,5	3,860	0,078	17897089815959

SAPATEIRA DUPLA “DESMONTÁVEL”

solapa



1589-1 | Black cx. c/ 4 pçs

Modular



1588-4 | Cromada cx. c/ 4 pçs

SAPATEIRA “EMPIHÁVEL”

solapa



1583-9 | Black unit. cx. c/ 6 pçs
1585-3 | Black cj. c/ 2 cx. c/ 4 pçs
1587-7 | Black cj. c/ 3 cx. c/ 3 pçs

Modular



1582-2 | Cromada unit. cx. c/ 6 pçs
1584-6 | Cromada cj. c/ 2 cx. c/ 4 pçs
1586-0 | Cromada cj. c/ 3 cx. c/ 3 pçs

Código	EAN	Descrição	Dimensão (cm)	Peso (kg)	Qt. cx. master	Dimensão cx. master (cm)	Peso cx. master (kg)	Cubagem cx. master (m³)	DUN 14
1582-2	7897089815822	SAPATEIRA EMPILHÁVEL UNITÁRIA - CROMADA	44 X 27 X 16	0,390	6	47 X 34 X 48,5	2,588	0,078	17897089815829
1583-9	7897089815839	SAPATEIRA EMPILHÁVEL UNITÁRIA - BLACK	44 X 27 X 16	0,390	6	47 X 34 X 48,5	2,588	0,078	17897089815836
1584-6	7897089815846	SAPATEIRA EMPILHÁVEL CONJ. C/ 2 - CROMADA	44 X 27 X 16	0,778	4	47 X 34 X 48,5	3,364	0,078	17897089815843
1585-3	7897089815853	SAPATEIRA EMPILHÁVEL CONJ. C/ 2 - BLACK	44 X 27 X 16	0,778	4	47 X 34 X 48,5	3,364	0,078	17897089815850
1586-0	7897089815860	SAPATEIRA EMPILHÁVEL CONJ. C/ 3 - CROMADA	44 X 27 X 16	1,166	3	47 X 34 X 48,5	3,752	0,078	17897089815867
1587-7	7897089815877	SAPATEIRA EMPILHÁVEL CONJ. C/ 3 - BLACK	44 X 27 X 16	1,166	3	47 X 34 X 48,5	3,752	0,078	17897089815874
1588-4	7897089815884	SAPATEIRA DUPLA DOBRÁVEL EMPILHÁVEL - CROMADA	46,5 X 27 X 27	0,732	4	47 X 20 X 28,5	3,170	0,027	17897089815881
1589-1	7897089815891	SAPATEIRA DUPLA DOBRÁVEL EMPILHÁVEL - BLACK	46,5 X 27 X 27	0,732	4	47 X 20 X 28,5	3,170	0,027	17897089815898

*Comprimento x Largura x Altura

IR PARA O ÍNDICE

SAPATEIRA DE PORTA "MODULAR"



solapa

1577-8 | Black unit. cx. c/ 10 pçs
 1579-2 | Black cj. c/ 2 cx. c/ 5 pçs
 1581-5 | Black cj. c/ 3 cx. c/ 3 pçs



1576-1 | Cromada unit. cx. c/ 10 pçs
 1578-5 | Cromada cj. c/ 2 cx. c/ 5 pçs
 1580-8 | Cromada cj. c/ 3 cx. c/ 3 pçs

SAPATEIRA P/ ARMÁRIO

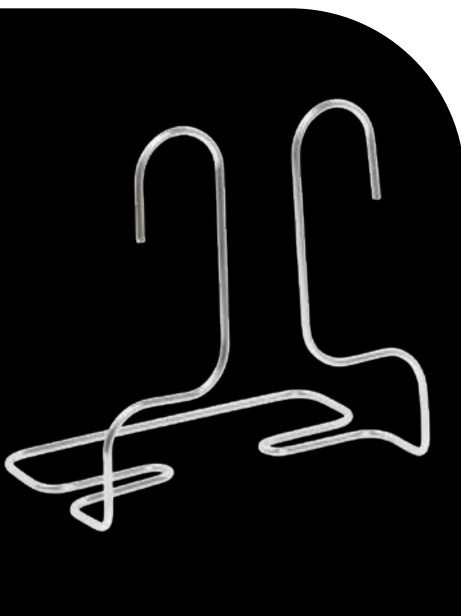

solapa



1590-7 | Cromada unit. cx. c/ 10 pçs
 1591-4 | Cromada cj. c/ 2 cx. c/ 6 pçs
 0799-5 | Cromada cj. c/ 3 cx. c/ 6 pçs

Código	EAN	Descrição	Dimensão (cm)	Peso (kg)	Qt. cx. master	Dimensão cx. master (cm)	Peso cx. master (kg)	Cubagem cx. master (m³)	DUN 14
799-5	7897089807995	SAPATEIRA P/ARMÁRIO CONJ. C/ 3 - CROMADA	17 X 10,5 X 18	0,362	6	19,5 X 15,5 X 23,5	2,258	0,007	17897089807992
1576-1	7897089815761	SAPATEIRA P/PORTA UNITÁRIA - CROMADA	47,5 X 10 X 26	0,192	10	47 X 20 X 28,5	2,150	0,027	17897089815768
1577-8	7897089815778	SAPATEIRA P/PORTA UNITÁRIA - BLACK	47,5 X 10 X 26	0,192	10	47 X 20 X 28,5	2,150	0,027	17897089815775
1578-5	7897089815785	SAPATEIRA P/PORTA CONJ. C/ 2 - CROMADA	47,5 X 10 X 26	0,382	5	47 X 20 X 28,5	2,150	0,027	17897089815782
1579-2	7897089815792	SAPATEIRA P/PORTA CONJ. C/ 2 - BLACK	47,5 X 10 X 26	0,382	5	47 X 20 X 28,5	2,150	0,027	17897089815799
1580-8	7897089815808	SAPATEIRA P/PORTA CONJ. C/ 3 - CROMADA	47,5 X 10 X 26	0,572	3	47 X 20 X 28,5	1,960	0,027	17897089815805
1581-5	7897089815815	SAPATEIRA P/PORTA CONJ. C/ 3 - BLACK	47,5 X 10 X 26	0,572	3	47 X 20 X 28,5	1,960	0,027	17897089815812
1590-7	7897089815907	SAPATEIRA P/ARMÁRIO UNITÁRIA - CROMADA	17 X 10,5 X 18	0,122	10	19,5 X 15,5 X 23,5	1,300	0,007	17897089815904
1591-4	7897089815914	SAPATEIRA P/ARMÁRIO CONJ. C/ 2 - CROMADA	17 X 10,5 X 18	0,242	6	19,5 X 15,5 X 23,5	1,540	0,007	17897089815911

CABIDE TINTUREIRO

- 003-3 | Cromado Individual cx. c/ 60 pçs
- 843-5 | Cromado c/ 2 cx. c/ 30 cj.
- 784-1 | Cromado c/ 3 cx. c/ 20 cj.
- 844-2 | Cromado c/ 4 cx. c/ 15 cj.
- 845-9 | Cromado c/ 5 cx. c/ 12 cj.
- 849-7 | Cromado c/ 6 cx. c/ 10 cj.
- 786-5 | Cromado c/ 10 cx. c/ 6 cj.
- 787-2 | Cromado c/ 30 cx. c/ 2 cj.



Maior
resistência



Maior
durabilidade

CABIDE C/ CAVAS P/ BLUSAS C/ ALÇAS

- 277-8 | Cromado Individual cx. c/ 60 cj.
- 855-8 | Cromado c/ 3 cx. c/ 20 cj.
- 856-5 | Cromado c/ 6 cx. c/ 10 cj.
- 793-3 | Cromado c/ 10 cx. c/ 6 cj.



Código	EAN	Descrição	Dimensão (cm)	Peso (kg)	Qt. cx. master	Dimensão cx. master (cm)	Peso cx. master (kg)	Cubagem cx. master (m³)	DUN 14
003-3	7897089800033	CABIDE TINTUREIRO CROMADO INDIVIDUAL	41 X 0,6 X 16,5	0,066	60	39 X 31 X 10,5	4,164	0,013	17897089800030
277-8	7897089802778	CABIDE TINTUREIRO C/ CAVA CROMADO INDIVIDUAL	41 X 0,6 X 16,5	0,066	60	39 X 31 X 10,5	4,164	0,013	17897089802775
784-1	7897089807841	CONJ. C/ 3 CABIDES TINTUREIRO CROMADO	41 X 0,6 X 16,5	0,196	20	39 X 31 X 10,5	4,138	0,013	17897089807848
786-5	7897089807865	CONJ. C/ 10 CABIDES TINTUREIRO CROMADO	41 X 0,6 X 16,5	0,642	6	39 X 31 X 10,5	4,038	0,013	17897089807862
787-2	7897089807872	CONJ. C/ 30 CABIDES TINTUREIRO CROMADO	41 X 0,6 X 16,5	1,890	2	39 X 31 X 10,5	3,974	0,013	17897089807879
793-3	7897089807933	CONJ. C/ 10 CABIDES TINTUREIRO C/ CAVA CROMADO	41 X 0,6 X 16,5	0,652	6	39 X 31 X 10,5	4,100	0,013	17897089807930
843-5	7897089808435	CONJ. C/ 2 CABIDES TINTUREIRO CROMADO	41 X 0,6 X 16,5	0,134	30	39 X 31 X 10,5	4,184	0,013	17897089808432
844-2	7897089808442	CONJ. C/ 4 CABIDES TINTUREIRO CROMADO	41 X 0,6 X 16,5	0,258	15	39 X 31 X 10,5	4,092	0,013	17897089808449
845-9	7897089808459	CONJ. C/ 5 CABIDES TINTUREIRO CROMADO	41 X 0,6 X 16,5	0,324	12	39 X 31 X 10,5	4,088	0,013	17897089808456
849-7	7897089808497	CONJ. C/ 6 CABIDES TINTUREIRO CROMADO	41 X 0,6 X 16,5	0,384	10	39 X 31 X 10,5	4,010	0,013	17897089808494
855-8	7897089808558	CONJ. C/ 3 CABIDES TINTUREIRO C/ CAVA CROMADO	41 X 0,6 X 16,5	0,200	20	39 X 31 X 10,5	4,152	0,013	17897089808555
856-5	7897089808565	CONJ. C/ 6 CABIDES TINTUREIRO C/ CAVA CROMADO	41 X 0,6 X 16,5	0,392	10	39 X 31 X 10,5	4,104	0,013	17897089808562

CABIDES P/ SAIA E SHORTS



851-0 | Cromado c/ 1 cx. c/ 50 pçs
 028-6 | Cromado c/ 2 cx. c/ 25 cj.
 852-7 | Cromado c/ 3 cx. c/ 20 cj.
 788-9 | Cromado c/ 10 cx. c/ 5 cj.



Maior
resistência



Maior
durabilidade

CABIDE CALCEIRO TRIPLO

CABIDE CAMISEIRO TRIPLO



789-6 | Cromado c/ 1 cx. c/ 24 pçs
 853-4 | Cromado c/ 2 cx. c/ 12 cj.
 854-1 | Cromado c/ 3 cx. c/ 8 cj.
 792-6 | Cromado c/ 10 cx. c/ 2 cj.

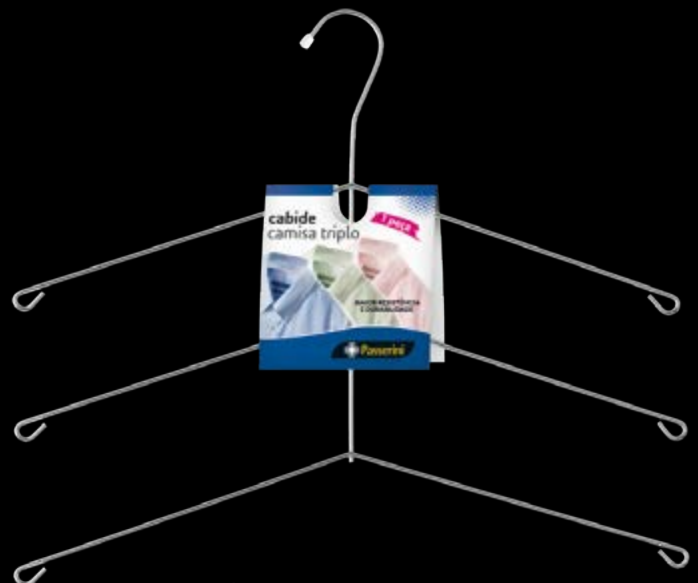

864-0 | Cabide Camiseiro Triplo
Cromado Individual. cx. c/ 24 pçs

Código	EAN	Descrição	Dimensão (cm)	Peso (kg)	Qt. cx. master	Dimensão cx. master (cm)	Peso cx. master (kg)	Cubagem cx. master (m³)	DUN 14
028-6	7897089800286	CONJ. C/ 2 UNID. CABIDE SAIA CROMADO	36 X 4 X 12,5	0,092	25	39 X 31 X 10,5	2,480	0,013	17897089800283
788-9	7897089807889	CONJ. C/ 10 UNID. CABIDE SAIA CROMADO	36 X 4 X 12,5	0,450	5	39 X 31 X 10,5	2,396	0,013	17897089807886
789-6	7897089807896	CABIDES CALCEIRO TRIPLO CROMADO INDIVIDUAL	38 X 0,6 X 29	0,126	24	39 X 31 X 10,5	3,206	0,013	17897089807893
792-6	7897089807926	CONJ. C/ 10 UNID. CABIDE CALCEIRO TRIPLO CROMADO	38 X 0,6 X 29	1,248	2	39 X 31 X 10,5	2,668	0,013	17897089807923
851-0	7897089808510	CABIDE SAIA CROMADO INDIVIDUAL	36 X 4 X 12,5	0,048	50	39 X 31 X 10,5	2,560	0,013	17897089808517
852-7	7897089808527	CONJ. C/ 3 UNID. CABIDE SAIA CROMADO	36 X 4 X 12,5	0,136	20	39 X 31 X 10,5	2,916	0,013	17897089808524
853-4	7897089808534	CONJ. C/ 2 UNID. CABIDE CALCEIRO TRIPLO CROMADO	38 X 0,6 X 29	0,250	12	39 X 31 X 10,5	3,176	0,013	17897089808531
854-1	7897089808541	CONJ. C/ 3 UNID. CABIDE CALCEIRO TRIPLO CROMADO	38 X 0,6 X 29	0,380	8	39 X 31 X 10,5	3,220	0,013	17897089808548
864-0	7897089808640	CABIDE CAMISEIRO TRIPLO CROMADO INDIVIDUAL	37 X 0,6 X 33	0,104	24	42 X 41 X 10	6,795	0,017	17897089808647

CARRINHO P/ COMPRAS



144-3 | Big Export c/ Rodas Especiais emb. c/ 1 pç



Organização
e funcionalidade



Maior capacidade
de peso e volume



Rodas
especiais



CARRINHO FEIRA



Estrutura
tubular



Maior
resistência



Rodas
reforçadas

001-9 | 4 Tubos
c/ Rodas
Reforçadas
am. c/ 5 pçs



025-5 | Cabo Longo
c/ Rodas Reforçadas am. c/ 5 pçs

Código	EAN	Descrição	Dimensão (cm)	Peso (kg)	Qt. cx. master	Dimensão cx. master (cm)	Peso cx. master (kg)	Cubagem cx. master (m³)	DUN 14
001-9	7897089800019	CARR. FEIRA 4 TUBOS C/ RODAS REFORÇADAS	48 X 35 X 89,5	2,316	5	52 X 31 X 95	11,580	0,153	67897089800011
025-5	7897089800255	CARR. FEIRA CABO LONGO C/ RODAS REFORÇADAS	48 X 35 X 80	2,004	5	52 X 27,5 X 90	10,035	0,129	67897089800257
144-3	7897089801443	CARRINHO P/ COMPRAS BIG EXPORT C/ RODAS ESPECIAIS	51,5 X 41 X 98	3,642	1	51,5 X 13 X 98	4,032	0,066	17897089801440

*Comprimento x Largura x Altura

IR PARA O ÍNDICE

CARRINHO P/ BOTIJÃO E VASO



573-1 | "Tubo" Cromado c/
Rodízio Reforçado cx. c/ 15 pçs

Estrutura
tubular

Com rodízios
especiais



1601-0 | "Tubo" Black c/
Rodízio Reforçado cx. c/ 15 pçs



937-1 | "Arame" Cromado
Reforçado cx. c/ 20 pçs

CARRINHO P/ CARGA

Rodas
reforçadas

Elásticos c/
presilhas plásticas

Estrutura
tubular 3/4

Sistema de
trava para base



242-6 | Reforçado 60 Kg
Dobrável c/ Rodas
Reforçadas am. c/ 4 pçs

145-0 | Big 80 Kg
Dobrável c/ Rodas
Especiais am. c/ 4 pçs



Código	EAN	Descrição	Dimensão (cm)	Peso (kg)	Qt. cx. master	Dimensão cx. master (cm)	Peso cx. master (kg)	Cubagem cx. master (m³)	DUN 14
145-0	7897089801450	CARR. P/ CARGA BIG 80 KG DOBRÁVEL C/ RODAS ESPECIAIS	41 X 39 X 96,5	2,596	4	65 X 44 X 35	10,860	0,100	17897089801457
242-6	7897089802426	CARR. P/ CARGA REFORÇADO 60 KG DOB. C/ RODAS REFORÇADAS	41 X 39 X 96	2,184	4	65 X 44 X 35	9,265	0,100	17897089802423
573-1	7897089805731	CARRINHO P/ BOTIJÃO E VASO "TUBO" CROM. C/ RODÍZIO REFORÇADO	32 X 32 X 11,5	0,348	15	65 X 38 X 36	6,015	0,089	17897089805738
937-1	7897089809371	CARRINHO P/ BOTIJÃO E VASO "ARAME" CROM. REFORÇADO	30,5 X 30,5 X 11	0,198	20	65 X 38 X 42	4,756	0,104	17897089809378
1601-0	7897089816010	CARRINHO P/ BOTIJÃO E VASO "TUBO" BLACK C/ RODÍZIO REFORÇADO	32 X 32 X 11,5	0,348	15	65 X 38 X 36	6,015	0,089	17897089816017

VARAL DE CHÃO C/ ABAS REFORÇADO



Dobrável
fácil de guardar



Fabricado
em aço



Acabamento
pintura epóxi

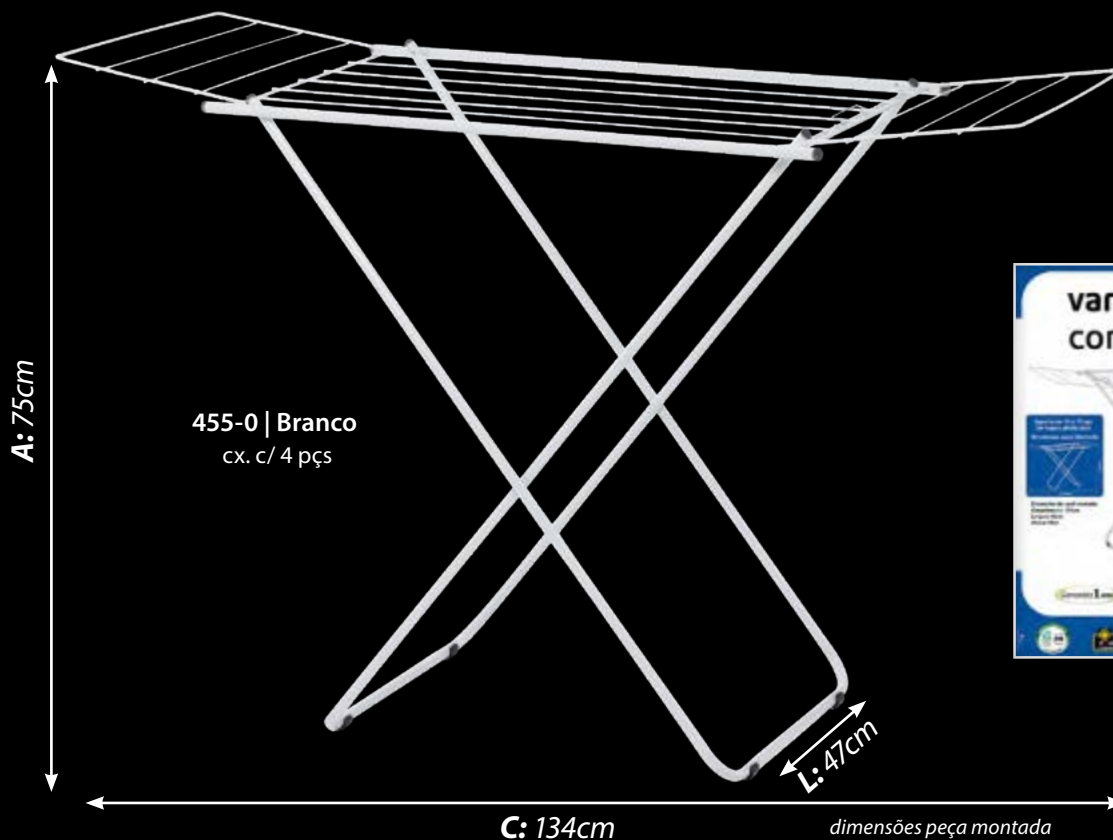

solapa



solapa



Código	EAN	Descrição	Dimensão (cm)	Peso (kg)	Qt. cx. master	Dimensão cx. master (cm)	Peso cx. master (kg)	Cubagem cx. master (m³)	DUN 14
455-0	7897089804550	VARAL DE CHÃO C/ ABAS REFORÇADO - EPOXI BRANCO	134 X 47 X 75	2,312	4	49 X 13,5 X 102,5	9,875	0,068	17897089804557
1604-1	7897089816041	VARAL DE CHÃO C/ ABAS REFORÇADO - EPOXI BLACK	134 X 47 X 75	2,312	4	49 X 13,5 X 102,5	9,875	0,068	17897089816048

*Comprimento x Largura x Altura

IR PARA O ÍNDICE

CESTO ORGANIZADOR



Organiza
seu espaço



Pés em
metal cromado



360-7 | Cesto Org.
TNT c/ Reforço
cx. c/ 6 pçs



solapa

VARAL PARA PORTA



Capacidade até
6kg distribuídos



461-1 | Dobrável Branco cx. c/ 6 pçs



solapa

SUPORE P/ MANGUEIRA



Maior resistência
à ferrugem



Otimiza
seu espaço



536-6 | Cromado cx. c/ 6 pçs



Código	EAN	Descrição	Dimensão (cm)	Peso (kg)	Qt. cx. master	Dimensão cx. master (cm)	Peso cx. master (kg)	Cubagem cx. master (m³)	DUN 14
360-7	7897089803607	CESTO ORGANIZADOR MÉDIO TNT - C/ REFORÇO	40,5 X 39 X 54	0,842	6	49 X 13,5 X 64	5,724	0,042	17897089803604
461-1	7897089804611	VARAL PARA PORTA DOBRÁVEL BRANCO	44,5 X 51 X 18	0,508	6	51,5 X 24 X 42	3,506	0,052	17897089804618
536-6	7897089805366	SUPORE P/ MANGUEIRA CROMADO	34,5 X 12,5 X 19	0,364	6	34 X 24 X 38,5	2,462	0,031	17897089805363

MULTIUSO - PORTA VASSOURAS / TOALHAS / PANOS



Ideal para
vassouras, escovas, toalhas



Organizador
de espaço



215-0 | Cromado cx. c/ 20 pçs



657-8 | Black cx. c/ 20 pçs



205-1 | Branco cx. c/ 20 pçs

Código	EAN	Descrição	Dimensão (cm)	Peso (kg)	Qt. cx. master	Dimensão cx. master (cm)	Peso cx. master (kg)	Cubagem cx. master (m³)	DUN 14
205-1	7897089802051	PORTA VASSOURAS BRANCO	42,5 X 4,5 X 13	0,224	20	45 X 31 X 12	4,614	0,017	17897089802058
215-0	7897089802150	PORTA VASSOURAS CROMADO	42,5 X 4,5 X 13	0,218	20	45 X 31 X 12	4,576	0,017	17897089802157
657-8	7897089806578	PORTA VASSOURAS BLACK	42,5 X 4,5 X 13	0,218	20	45 X 31 X 12	4,620	0,017	17897089806575

*Comprimento x Largura x Altura

IR PARA O ÍNDICE

ORGANIZADOR DE **FERRO E TÁBUA**

 **Organize**
sua lavanderia

935-7 | Cromado
cx. c/ 12 pçs



TÁBUA DE PASSAR ROUPAS **REFORÇADA - GRANDE**

 **Forro térmico**
incluso

 **Fabricado em aço**
pés com estrutura tubular 3/4

 **Acabamento**
pintura epóxi



463-5 | Big (c/ Forro Térmico)
cx. c/ 2 pçs



Código	EAN	Descrição	Dimensão (cm)	Peso (kg)	Qt. cx. master	Dimensão cx. master (cm)	Peso cx. master (kg)	Cubagem cx. master (m³)	DUN 14
463-5	7897089804635	TÁBUA DE PASSAR ROUPAS BIG (C/FORRO TÉRMICO)	104 X 34,5 X 89	4,700	2	123,5 X 13,5 X 36,5	9,475	0,061	17897089804632
935-7	7897089809357	PORTA FERRO E TÁBUA CROMADO	19 X 8 X 28	0,106	12	34 X 24 X 38,5	1,570	0,031	17897089809354

CANTONEIRA



175-7 | Tripla Grande Luxo Cromada cx. c/ 4 pçs



696-7 | Tripla Cromada cx. c/ 8 pçs



281-5 | Dupla Grande Laminada Cromada cx. c/ 4 pçs
• Acompanha parafusos e buchas

Código	EAN	Descrição	Dimensão (cm)	Peso (kg)	Qt. cx. master	Dimensão cx. master (cm)	Peso cx. master (kg)	Cubagem cx. master (m³)	DUN 14
175-7	7897089801757	CANTO TRIPLA LUXO GRANDE CROMADO	24 X 24 X 56	0,674	4	64 X 38 X 42	3,372	0,102	47897089801755
281-5	7897089802815	CANTO DUPLO LAMINADO CROMADO C/PARAFUSOS E BUCHAS	23 X 23 X 32,5	0,612	4	51,5 X 24 X 33,5	2,822	0,041	17897089802812
696-7	7897089806967	CANTONEIRA TRIPLA CROMADA	18,5 X 18,5 X 58	0,380	8	64,5 X 37,5 X 40	3,788	0,097	17897089806964

*Comprimento x Largura x Altura

IR PARA O ÍNDICE

CANTONEIRA



174-0 | Dupla Grande Luxo Cromada
cx. c/ 8 pçs



1597-6 | Dupla Grande Luxo Black
cx. c/ 8 pçs



706-3 | Prateleira Cromada
cx. c/ 10 pçs



918-0 | Dupla Cromada
cx. c/ 10 pçs



207-5 | Dupla Branca
cx. c/ 10 pçs

Código	EAN	Descrição	Dimensão (cm)	Peso (kg)	Qt. cx. master	Dimensão cx. master (cm)	Peso cx. master (kg)	Cubagem cx. master (m³)	DUN 14
174-0	7897089801740	CANTO DUPLO LUXO GRANDE CROMADO	23 X 23 X 32,5	0,440	8	47 X 34 X 48,5	4,034	0,078	87897089801746
207-5	7897089802075	CANTO DUPLO BRANCO	18,5 X 18,5 X 35	0,256	10	53 X 37,5 X 40,5	3,144	0,080	17897089802070
706-3	7897089807063	CANTO 1 PRATELEIRA CROMADO	20 X 20 X 7	0,109	10	39 X 31 X 10,5	1,290	0,013	17897089807060
918-0	7897089809180	CANTO DUPLO CROMADO	18,5 X 18,5 X 35	0,252	10	53 X 37,5 X 40,5	3,122	0,080	17897089809187
1597-6	7897089815976	CANTO DUPLO LUXO GRANDE BLACK	23 X 23 X 32,5	0,44	8	47 X 34 X 48,5	4,034	0,078	17897089815973

PORTA TOALHAS



867-1 | Cabide p/ Porta 10 Ganchos
Reforçado Cromado cx. c/ 12 pçs

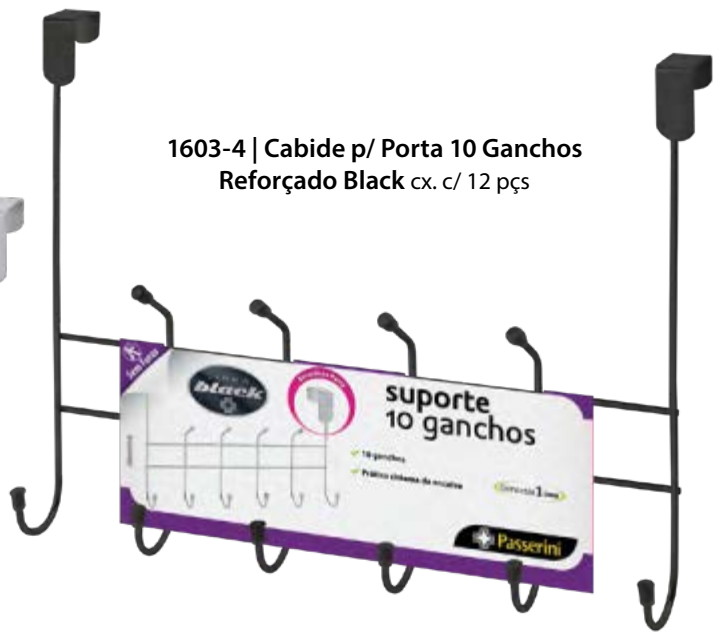

1603-4 | Cabide p/ Porta 10 Ganchos
Reforçado Black cx. c/ 12 pçs



375-1 | 6 Ganchos Laminado
p/ Porta cx. c/ 6 pçs

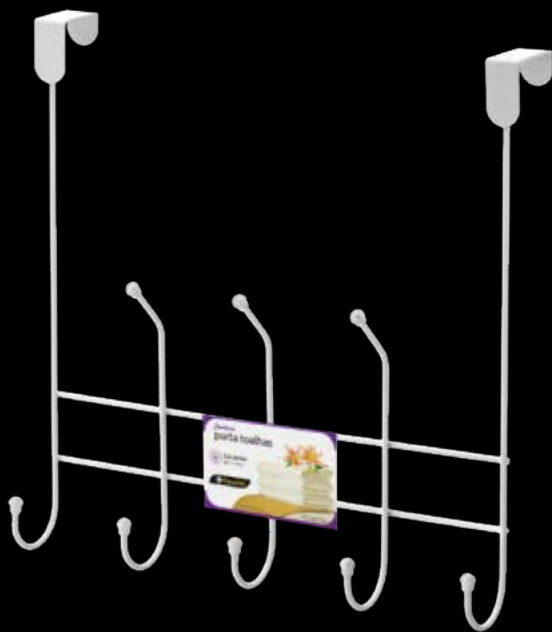

199-3 | Cabide 8 Ganchos p/ Porta
Branco cx. c/ 15 pçs



726-1 | Cabide Porta
Toalhas 1 Gancho
Cromado c/ Ventosa
cx. c/ 36 pçs

Código	EAN	Descrição	Dimensão (cm)	Peso (kg)	Qt. cx. master	Dimensão cx. master (cm)	Peso cx. master (kg)	Cubagem cx. master (m³)	DUN 14
199-3	7897089801993	CABIDE 8 GANCHOS P/ PORTA BRANCO	32 X 9 X 33,5	0,266	15	41 X 26,5 X 37	4,340	0,040	17897089801990
375-1	7897089803751	CABIDE 6 GANCHOS LAMINADO P/ PORTA CROMADO	35 X 9 X 33,5	0,346	6	41,5 X 41,5 X 14	2,472	0,024	17897089803758
726-1	7897089807261	CABIDE PORTA TOALHAS 1 GANCHO CROMADO C/ VENTOSA	3,5 X 4 X 9,8	0,012	36	19,5 X 15,5 X 12	0,470	0,004	17897089807268
867-1	7897089808671	CABIDE P/ PORTA 10 GANCHOS REFORÇADO CROMADO	40 X 9 X 33,5	0,320	12	42 X 41 X 21	4,486	0,036	17897089808678
1603-4	7897089816034	CABIDE P/ PORTA 10 GANCHOS REFORÇADO - BLACK	40 X 9 X 33,5	0,32	12	42 X 41 X 21	4,486	0,036	17897089816031

*Comprimento x Largura x Altura

IR PARA O ÍNDICE

PORTA TOALHAS

677-6 | Cabide Toalhas p/ Porta 7 Ganchos Cromado
cx. c/ 8 pçs



946-3 | Cabide Toalhas p/ Porta 7 Ganchos Black
cx. c/ 8 pçs



220-4 | Cabide 4 Ganchos p/ Porta Cromado
cx. c/ 20 pçs



602-8 | Cabide Porta Toalhas 4 Ganchos Cromado c/ Ventosa
cx. c/ 24 pçs

235-8 | Cabide Porta Toalhas 4 Ganchos Cromado
cx. c/ 30 pçs



Código	EAN	Descrição	Dimensão (cm)	Peso (kg)	Qt. cx. master	Dimensão cx. master (cm)	Peso cx. master (kg)	Cubagem cx. master (m³)	DUN 14
220-4	7897089802204	CABIDE 4 GANCHOS P/ PORTA CROMADO	33 X 9 X 12,5	0,058	20	39 X 31 X 10,5	1,368	0,013	17897089802201
235-8	7897089802358	CABIDE PORTA TOALHAS 4 GANCHOS CROMADO	35,5 X 6 X 9	0,640	30	39 X 31 X 10,5	2,064	0,013	67897089802350
602-8	7897089806028	CABIDE PORTA TOALHAS 4 GANCHOS CROMADO C/ VENTOSA	37 X 6 X 9	0,070	24	39 X 31 X 10,5	1,886	0,013	17897089806025
677-6	7897089806776	CABIDE PORTA TOALHAS P/ PORTA 7 GANCHOS CROMADO	30 X 9 X 29,5	0,148	8	39 X 31 X 10,5	1,198	0,013	17897089806773
946-3	7897089809463	CABIDE PORTA TOALHAS P/ PORTA 7 GANCHOS BLACK	30 X 9 X 29,5	0,148	8	39 X 31 X 10,5	1,368	0,013	17897089809460

SUPOORTE P/ PAPEL HIGIÊNICO

372-0 | Luxo "Sem Furos" Cromado
cx. c/ 6 pçs

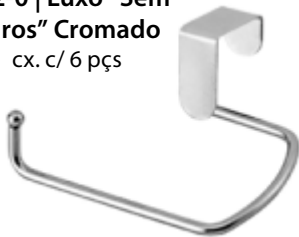

776-6 | Luxo "Sem Furos" Black
cx. c/ 6 pçs



941-8 | Prático "Sem Furos" Cromado
cx. c/ 10 pçs



947-0 | Prático "Sem Furos" Black
cx. c/ 10 pçs



774-2 | Duplo Luxo "Sem Furos" Cromado
cx. c/ 12 pçs



775-9 | Duplo Luxo "Sem Furos" Black
cx. c/ 12 pçs



944-9 | Duplo Prático "Sem Furos" Cromado
cx. c/ 10 pçs



956-2 | Duplo Prático "Sem Furos" Black
cx. c/ 10 pçs



Código	EAN	Descrição	Dimensão (cm)	Peso (kg)	Qt. cx. master	Dimensão cx. master (cm)	Peso cx. master (kg)	Cubagem cx. master (m³)	DUN 14
372-0	7897089803720	SUPOORTE P/PAPEL HIGIÊNICO CROMADO "SEM FUROS"	13 X 10 X 7	0,064	6	19,5 X 15,5 X 12	0,504	0,004	17897089803727
774-2	7897089807742	SUP. PAPEL HIG. DUPLO SIMPLES "SEM FUROS" CROM	13 X 9 X 22,5	0,162	12	45 X 31 X 12	2,156	0,017	17897089807749
775-9	7897089807759	SUP. PAPEL HIG. DUPLO SIMPLES "SEM FUROS" BLACK	13 X 9 X 22,5	0,160	12	45 X 31 X 12	2,178	0,017	17897089807756
776-6	7897089807766	SUPOORTE P/ PAPEL HIGIÊNICO BLACK "SEM FUROS"	13 X 10 X 7	0,066	6	19,5 X 15,5 X 12	0,510	0,004	17897089807763
941-8	7897089809418	SUPOORTE P/ PAPEL HIG. PRÁTICO "SEM FUROS" CROMADO	13 X 10 X 6	0,043	10	19,5 X 15,5 X 23,5	0,542	0,007	17897089809415
944-9	7897089809449	SUPOORTE P/ PAPEL HIG. DUPLO PRÁTICO "SEM FUROS" CROMADO	13 X 10 X 22	0,087	10	39 X 31 X 10,5	1,055	0,013	17897089809446
947-0	7897089809470	SUPOORTE P/ PAPEL HIG. PRÁTICO "SEM FUROS" BLACK	13 X 10 X 6	0,043	10	19,5 X 15,5 X 23,5	0,542	0,007	17897089809477
956-2	7897089809562	SUPOORTE P/ PAPEL HIG. DUPLO PRÁTICO "SEM FUROS" BLACK	13 X 10 X 22	0,087	10	39 X 31 X 10,5	1,055	0,013	17897089809569

*Comprimento x Largura x Altura

IR PARA O ÍNDICE

SUPORTE P/ PAPEL HIGIÊNICO



945-6 | p/ 2
Rolos "Prático"
Cromado
cx. c/ 6 pçs



373-7 | p/ 3 Rolos
"Sem Furos"
Cromado cx. c/ 6 pçs



008-8 | p/ 3
Rolos "Prático"
Cromado
cx. c/ 12 pçs



465-9 | Luxo 3+1
Cromado
cx. c/ 6 pçs



1596-9 | Luxo 3+1
Black cx. c/ 6 pçs



Código	EAN	Descrição	Dimensão (cm)	Peso (kg)	Qt. cx. master	Dimensão cx. master (cm)	Peso cx. master (kg)	Cubagem cx. master (m³)	DUN 14
008-8	7897089800088	PORTA PAPEL HIGIÊNICO 3 ROLOS CROMADO	12,5 X 11 X 34	0,148	12	51,5 X 24 X 42	2,210	0,052	67897089800080
373-7	7897089803737	SUPORTE P/ PAPEL HIGIÊNICO P/ 3 ROLOS CROMADO "SEM FUROS"	12,5 X 13 X 35	0,238	6	34 X 24 X 38,5	1,716	0,031	17897089803734
465-9	7897089804659	SUPORTE P/ PAPEL HIGIÊNICO LUXO "3 + 1" CROMADO	14 X 14 X 51,5	0,540	6	49 X 13,5 X 54	3,638	0,036	17897089804656
945-6	7897089809456	PORTA PAPEL HIG. 3 ROLOS PRATICO CROMADO	12 X 11 X 23	0,115	6	39 X 31 X 10,5	0,888	0,013	17897089809453
1596-9	7897089815969	SUPORTE P/ PAPEL HIGIÊNICO LUXO "3 + 1" - BLACK	14 X 14 X 51,5	0,54	6	49 X 13,5 X 54	3,638	0,036	17897089815966

SUPORE P/ PAPEL HIGIÊNICO



331-7 | Luxo Cromado
cx. c/ 8 pçs



624-0 | Luxo Black
cx. c/ 8 pçs



328-7
c/ Revisteiro Cromado
cx. c/ 12 pçs



623-3
c/ Revisteiro Black
cx. c/ 12 pçs



841-1
c/ Prateleira Cromado
cx. c/ 12 pçs



831-2
c/ Prateleira Black
cx. c/ 12 pçs



Código	EAN	Descrição	Dimensão (cm)	Peso (kg)	Qt. cx. master	Dimensão cx. master (cm)	Peso cx. master (kg)	Cubagem cx. master (m³)	DUN 14
328-7	7897089803287	REVISTEIRO C/ P. PAPEL HIGIÊNICO CROMADO	15,5 X 17,5 X 47,5	0,424	12	47 X 34 X 48,5	5,620	0,078	17897089803284
331-7	7897089803317	SUPORE P/ PAPEL HIGIÊNICO LUXO CROMADO	18 X 17 X 44,5	0,372	8	47 X 20 X 28,5	3,248	0,027	17897089803314
623-3	7897089806233	REVISTEIRO C/ P. PAPEL HIGIÊNICO BLACK	15,5 X 17,5 X 47,5	0,424	12	47 X 34 X 48,5	5,654	0,078	17897089806230
624-0	7897089806240	SUPORE P/ PAPEL HIGIÊNICO LUXO BLACK	18 X 17 X 44,5	0,372	8	47 X 20 X 28,5	3,260	0,027	17897089806247
831-2	7897089808312	SUPORE P/ PAPEL HIGIÊNICO C/ PRATELEIRA BLACK	20 X 17 X 47,5	0,450	12	47 X 34 X 48,5	5,948	0,078	17897089808319
841-1	7897089808411	SUPORE P/ PAPEL HIGIÊNICO C/ PRATELEIRA CROMADO	20 X 17 X 47,5	0,450	12	47 X 34 X 48,5	5,948	0,078	17897089808418

*Comprimento x Largura x Altura

IR PARA O ÍNDICE

SUPORTE P/ PAPEL HIGIÊNICO DE CHÃO

1592-1
Laminado
Cromado
cx. c/ 6 pçs



1593-8
Laminado
Black
cx. c/ 6 pçs



solapa



524-3 | Luxo c/ Lixeira
Branca 6 Litros
cx. c/ 6 pçs



525-0 | Luxo c/ Lixeira
Preta 6 Litros
cx. c/ 6 pçs



solapa



522-9 | Com Lixeira
Branca 6 Litros
cx. c/ 6 pçs



523-6 | Com Lixeira
Preta 6 Litros
cx. c/ 6 pçs



solapa



Código	EAN	Descrição	Dimensão (cm)	Peso (kg)	Qt. cx. master	Dimensão cx. master (cm)	Peso cx. master (kg)	Cubagem cx. master (m³)	DUN 14
522-9	7897089805229	SUPORTE P/ PAPEL HIGIÊNICO C/ LIXEIRA BRANCA 6 LITROS	22,5 X 22 X 48	0,606	6	50 X 26 X 50,5	4,166	0,066	17897089805226
523-6	7897089805236	SUPORTE P/ PAPEL HIGIÊNICO C/ LIXEIRA PRETA 6 LITROS	22,5 X 22 X 48	0,606	6	50 X 26 X 50,5	4,166	0,066	17897089805233
524-3	7897089805243	SUPORTE LUXO P/ PAPEL HIGIÊNICO C/ LIXEIRA BRANCA 6 LITROS	28 X 22 X 53	0,750	6	50 X 26 X 56	5,042	0,073	17897089805240
525-0	7897089805250	SUPORTE LUXO P/ PAPEL HIGIÊNICO C/ LIXEIRA PRETA 6 LITROS	28 X 22 X 53	0,750	6	50 X 26 X 56	5,042	0,073	17897089805257
1592-1	7897089815921	SUPORTE P/ PAPEL HIGIÊNICO DE CHÃO LAMINADO - CROMADO	13,5 X 16 X 45	0,332	6	47 X 20 X 28,5	2,242	0,027	17897089815928
1593-8	7897089815938	SUPORTE P/ PAPEL HIGIÊNICO DE CHÃO LAMINADO - BLACK	13,5 X 16 X 45	0,332	6	47 X 20 X 28,5	2,242	0,027	17897089815935

SUPORTE P/ TOALHAS



374-4 | Duplo p/ Box Laminado "Sem Furos"
Cromado cx. c/ 6 pçs



777-3 | Duplo p/ Box Laminado "Sem Furos"
Black cx. c/ 6 pçs



1569-3 | Duplo p/
Box Prático "Sem
Furos" Cromado
cx. c/ 6 pçs



1570-9 | Duplo p/
Box Prático "Sem
Furos" Black
cx. c/ 6 pçs

Código	EAN	Descrição	Dimensão (cm)	Peso (kg)	Qt. cx. master	Dimensão cx. master (cm)	Peso cx. master (kg)	Cubagem cx. master (m³)	DUN 14
374-4	7897089803744	SUPORTE P/ 2 TOALHAS LAMINADO CROMADO "SEM FUROS"	42,2 X 14 X 32	0,372	6	42 X 32 X 33	2,548	0,044	17897089803741
777-3	7897089807773	SUPORTE P/ 2 TOALHAS LAMINADO BLACK "SEM FUROS"	42,2 X 14 X 32	0,368	6	42 X 32 X 33	2,642	0,044	17897089807770
1569-3	7897089815693	TOALHEIRO DUPLO P/ BOX PRÁTICO "SEM FUROS" CROMADO	36,5 X 13 X 24	0,169	6	47 X 20 X 28,5	1,280	0,027	17897089815690
1570-9	7897089815709	TOALHEIRO DUPLO P/ BOX PRÁTICO "SEM FUROS" BLACK	36,5 X 13 X 24	0,169	6	47 X 20 X 28,5	1,280	0,027	17897089815706

*Comprimento x Largura x Altura

IR PARA O ÍNDICE

SUPORE P/ TOALHAS



caixa litografada



487-1 | Toalheiro p/
Pia Cromado c/ Caixa
Litografada cx. c/ 6 pçs



515-1 | Toalheiro
p/ Pia Cromado
cx. c/ 6 pçs

solapa



620-2 | Toalheiro
p/ Pia Black
cx. c/ 6 pçs

Código	EAN	Descrição	Dimensão (cm)	Peso (kg)	Qt. cx. master	Dimensão cx. master (cm)	Peso cx. master (kg)	Cubagem cx. master (m³)	DUN 14
487-1	7897089804871	TOALHEIRO P/ PIA CROMADO C/ CAIXA LITOGRAFADA	17,7 X 9,5 X 32,5	0,320	6	51,5 X 24 X 42	2,366	0,052	67897089804873
515-1	7897089805151	TOALHEIRO P/ PIA CROMADO	17,7 X 9,5 X 32,5	0,222	6	39 X 31 X 10,5	1,518	0,013	17897089805158
620-2	7897089806202	TOALHEIRO P/ PIA BLACK	17,7 X 9,5 X 32,5	0,224	6	39 X 31 X 10,5	1,532	0,013	17897089806209

SUPOORTE P/ SECADOR



466-6 | Organizador p/ Escovas, Secador e Chapinha Cromado c/ Caixa Litografada cx. c/ 6 pçs



526-7 | Suporte p/ Escovas, Secador e Chapinha p/ Bancada Cromado cx. c/ 8 pçs



0618-9 | Suporte p/ Escovas, Secador e Chapinha p/ Bancada Black cx. c/ 8 pçs

339-3 | Suporte p/ Secador de Cabelo Cromado cx. c/ 6 pçs



619-6 | Suporte p/ Secador de Cabelo Black cx. c/ 6 pçs

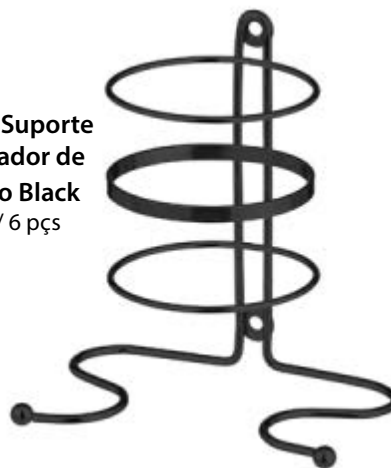

Código	EAN	Descrição	Dimensão (cm)	Peso (kg)	Qt. cx. master	Dimensão cx. master (cm)	Peso cx. master (kg)	Cubagem cx. master (m³)	DUN 14
339-3	7897089803393	SUPOORTE CROMADO P/ SECADOR DE CABELOS C/ PARAF. E BUCHA	19 X 10,5 X 21	0,208	6	31 X 31 X 21	1,516	0,020	17897089803390
466-6	7897089804666	ORG. P/ ESCOVAS, SECADOR E CHAPINHA CROM. C/ CX. LITOGRAFADA	33,5 X 10 X 30	0,512	6	47 X 34 X 48,5	3,632	0,078	17897089804663
526-7	7897089805267	SUPOORTE P/ SECADOR E CHAPINHA P/ BANCADA CROMADO	26 X 12 X 20	0,614	8	34 X 24 X 38,5	5,266	0,031	17897089805264
618-9	7897089806189	SUPOORTE P/ SECADOR E CHAPINHA "BANCADA" BLACK	26 X 12 X 20	0,614	8	34 X 24 X 38,5	5,216	0,031	17897089806186
619-6	7897089806196	SUPOORTE BLACK P/ SECADOR DE CABELOS C/ PARAF. E BUCHA	19 X 10,5 X 21	0,212	6	31 X 31 X 21	1,518	0,020	17897089806193

PRATELEIRAS



377-5 | Prateleira Dupla p/ Box Laminada Cromada "Sem Furos" cx. c/ 3 pçs



378-2 | Prateleira Multiuso Luxo Laminada Cromada cx. c/ 6 pçs



0687-5 | Prateleira Multiuso Luxo Laminada Black cx. c/ 6 pçs

Código	EAN	Descrição	Dimensão (cm)	Peso (kg)	Qt. cx. master	Dimensão cx. master (cm)	Peso cx. master (kg)	Cubagem cx. master (m³)	DUN 14
377-5	7897089803775	PRATELEIRA DUPLA LAMINADA CROMADA "SEM FURROS"	29 X 21 X 56	0,904	3	53 X 37,5 X 32	3,224	0,064	17897089803772
378-2	7897089803782	PRATELEIRA MULTIUSO LUXO CROMADA C/ PARAFUSOS E BUCHAS	39 X 13 X 11	0,524	6	41,5 X 41,5 X 15	3,582	0,026	17897089803789
687-5	7897089806875	PRATELEIRA MULTIUSO LUXO BLACK C/ PARAFUSOS E BUCHAS	39,3 X 13 X 13	0,528	6	41,5 X 41,5 X 15	3,580	0,026	17897089806872

SUPOORTE P/ SHAMPOO

330-0 | Duplo Laminado Cromado
cx. c/ 6 pçs

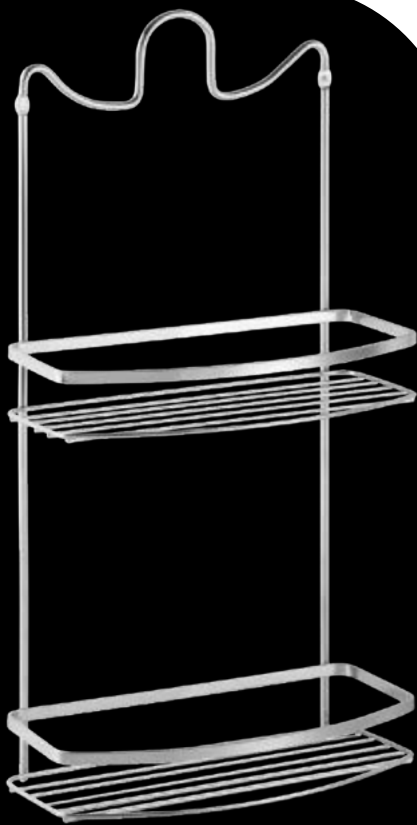

133-7 | Duplo p/ Box "Sem Furos"
Cromado
cx. c/ 6 pçs

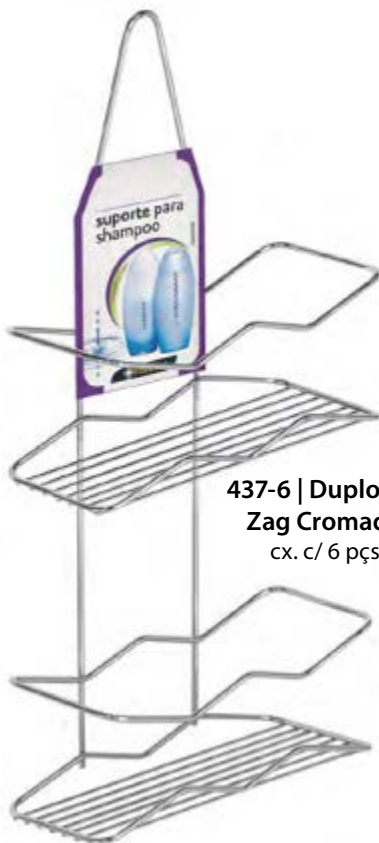

437-6 | Duplo Zig Zag Cromado
cx. c/ 6 pçs

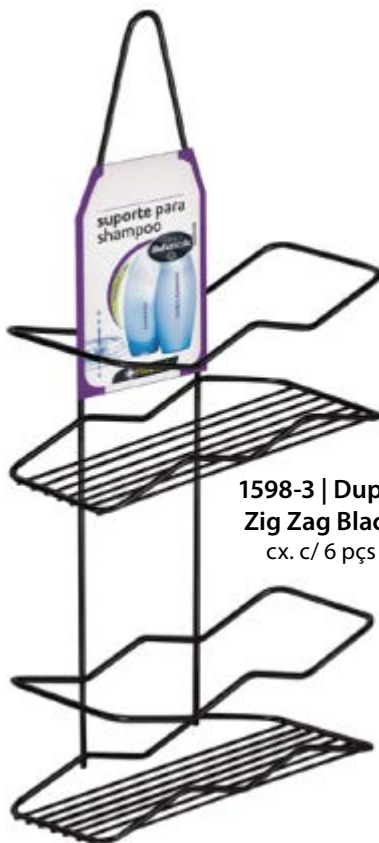

1598-3 | Duplo Zig Zag Black
cx. c/ 6 pçs



436-9 | Zig Zag Cromado
cx. c/ 6 pçs

Código	EAN	Descrição	Dimensão (cm)	Peso (kg)	Qt. cx. master	Dimensão cx. master (cm)	Peso cx. master (kg)	Cubagem cx. master (m³)	DUN 14
133-7	7897089801337	PORTA SHAMPOO DUPLO LUXO CROMADO P/ BOX "SEM FURROS"	22 X 10 X 64,5	0,344	6	64,5 X 37,5 X 25	2,700	0,060	17897089801334
330-0	7897089803300	SUPOORTE P/ SHAMPOO DUPLO LAM. CROM.C/ PARAF. E BUCHAS	22,8 X 11 X 45	0,598	6	51,5 X 24 X 32	4,012	0,040	17897089803307
436-9	7897089804369	PORTA SHAMPOO LUXO ZIG ZAG CROMADO	22 X 10 X 24	0,158	6	31 X 31 X 21	1,192	0,020	67897089804361
437-6	7897089804376	PORTA SHAMPOO DUPLO ZIG ZAG CROMADO	22 X 10 X 48	0,300	6	51,5 X 24 X 32	2,224	0,040	67897089804378
1598-3	7897089815983	PORTA SHAMPOO DUPLO ZIG ZAG - BLACK	22 X 10 X 48	0,3	6	51,5 X 24 X 32	2,224	0,040	17897089815980

*Comprimento x Largura x Altura

IR PARA O ÍNDICE

SUPORTE P/ SHAMPOO

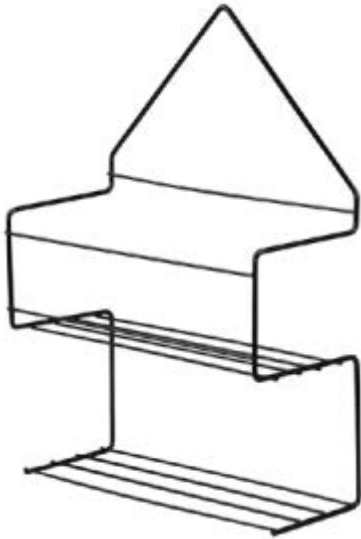

1565-5 | Duplo "Prático"
Black cx. c/ 10 pçs

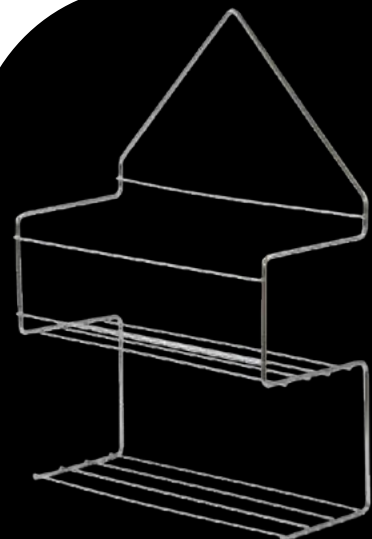

1564-8 | Duplo "Prático"
Cromado cx. c/ 10 pçs



917-3 | Duplo Reto
Cromado
cx. c/ 12 pçs



699-8 | Simples "Prático"
Cromado cx. c/ 12 pçs



727-8 | Porta Sabonete
c/ Ventosa cx. c/ 24 pçs



Código	EAN	Descrição	Dimensão (cm)	Peso (kg)	Qt. cx. master	Dimensão cx. master (cm)	Peso cx. master (kg)	Cubagem cx. master (m³)	DUN 14
699-8	7897089806998	PORTA ROLO TRIPLÓ "PRÁTICO" CROMADO	19 X 20 X 9	0,084	12	31 X 31 X 21	1,238	0,020	17897089806995
727-8	7897089807278	PORTA SABONETE CROMADO C/ VENTOSA	12 X 10 X 9,5	0,042	24	39 X 31 X 10,5	1,192	0,013	17897089807275
917-3	7897089809173	PORTA SHAMPOO DUPLO RETO CROMADO	17,5 X 9,5 X 37	0,184	12	42 X 32 X 33	2,600	0,044	17897089809170
1564-8	7897089815648	PORTA SHAMPOO DUPLO "PRÁTICO" CROMADO	20 X 9 X 27	0,126	10	34 X 24 X 38,5	1,470	0,031	17897089815645
1565-5	7897089815655	PORTA SHAMPOO DUPLO "PRÁTICO" BLACK	20 X 9 X 27	0,126	10	34 X 24 X 38,5	1,470	0,031	17897089815652

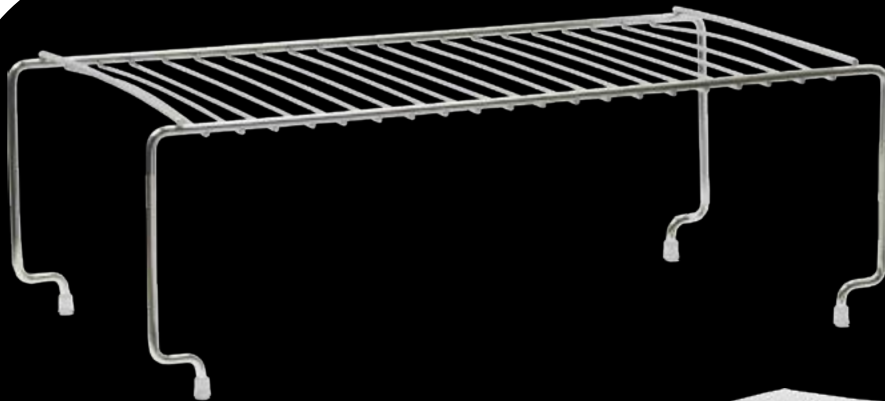

solapa



499-4 | Prateleira Organizadora Reforçada "Modular" Cromada cx. c/ 6 pçs



solapa

507-6 | Canto Triplo Organizador Reforçado Cromado cx. c/ 6 pçs



solapa



1573-0 | Canto Organizador "Prático" Cromado cx. c/ 6 pçs



solapa



1572-3 | Prateleira Organizadora "Prática" Cromada cx. c/ 6 pçs

Código	EAN	Descrição	Dimensão (cm)	Peso (kg)	Qt. cx. master	Dimensão cx. master (cm)	Peso cx. master (kg)	Cubagem cx. master (m³)	DUN 14
499-4	7897089804994	PRATELEIRA ORGANIZADORA GRANDE REFORÇADA CROMADA	42 X 22 X 15	0,526	6	42,5 X 26 X 30	3,512	0,033	17897089804991
507-6	7897089805076	CANTO ORGANIZADOR REFORÇADO CROMADO	25,5 X 25,5 X 21,5	0,538	6	50 X 26 X 50,5	3,760	0,066	17897089805073
1572-3	7897089815723	PRATELEIRA ORGANIZADOR "PRÁTICA" CROMADA	32 X 19,5 X 15	0,177	6	31 X 31 X 21	1,238	0,020	17897089815720
1573-0	7897089815730	CANTO ORGANIZADOR "PRÁTICO" CROMADO	25 X 25 X 11	0,187	6	31 X 31 X 21	1,280	0,020	17897089815737

solapa



368-3 | Gaveta Organizadora Média Reforçada Cromada cx. c/ 6 pçs



1568-6 | Gaveta Organizadora Pequena Cromada cx. c/ 10 pçs



415-4 | Organizador p/ 18 Pratos Cromado (com Pés Arame 5,50mm) cx. c/ 12 pçs

solapa



solapa

717-9 | Organizador p/ 18 Pratos Black (com Pés Arame 5,50mm) cx. c/ 12 pçs



Código	EAN	Descrição	Dimensão (cm)	Peso (kg)	Qt. cx. master	Dimensão cx. master (cm)	Peso cx. master (kg)	Cubagem cx. master (m³)	DUN 14
368-3	7897089803683	GAVETA ORGANIZADORA MÉDIA REFORÇADA CROMADA	35,5 X 22 X 12	0,440	6	34 X 24 X 25,5	2,918	0,021	17897089803680
415-4	7897089804154	ORGANIZADOR P/ 18 PRATOS CROM. (COM PÉS ARAME 5,50MM)	38,5 X 22 X 5,5	0,314	12	42 X 41 X 21	4,348	0,036	17897089804151
717-9	7897089807179	ORGANIZADOR P/ 18 PRATOS BLACK (COM PÉS ARAME 5,50MM)	38,5 X 22 X 5,5	0,314	12	42 X 41 X 21	4,410	0,036	17897089807176
1568-6	7897089815686	GAVETA ORGANIZADOR PEQUENA CROMADA	24 X 20 X 12,5	0,148	10	31 X 31 X 21	1,650	0,020	17897089815683



solapa



497-0 | Organizador Reforçado para Formas, Tampas e Frigideiras Cromado cx. c/ 6 pçs



solapa



498-7 | Organizador de Tampas Cromado cx. c/ 6 pçs

Código	EAN	Descrição	Dimensão (cm)	Peso (kg)	Qt. cx. master	Dimensão cx. master (cm)	Peso cx. master (kg)	Cubagem cx. master (m³)	DUN 14
497-0	7897089804970	ORGANIZADOR DE FORMAS, TRAVESSAS E FRIGIDEIRAS CROMADO	31,5 X 26 X 20,8	0,620	6	34 X 24 X 28	4,022	0,023	17897089804977
498-7	7897089804987	ORGANIZADOR DE TAMPAS CROMADO	25,5 X 8 X 41,5	0,420	6	41,5 X 41,5 X 15	2,930	0,026	17897089804984

*Comprimento x Largura x Altura

IR PARA O ÍNDICE

solapa



**496-3 | Organizador
Reforçado p/ Taças Cromado**
cx. c/ 6 pçs



solapa



**383-6 | Organizador Reforçado p/ Xícaras
Cromado cx. c/ 6 pçs**



**531-1 | Prateleira Organizadora p/
Armário Cromada cx. c/ 6 pçs**

Código	EAN	Descrição	Dimensão (cm)	Peso (kg)	Qt. cx. master	Dimensão cx. master (cm)	Peso cx. master (kg)	Cubagem cx. master (m³)	DUN 14
383-6	7897089803836	SUPORTE LUXO ORGANIZADOR DE XÍCARAS CROMADO	27 X 16 X 6	0,216	6	39 X 31 X 10,5	1,472	0,013	17897089803833
496-3	7897089804963	SUPORTE LUXO ORGANIZADOR DE TAÇAS CROMADO	34 X 27 X 7,8	0,404	6	34 X 24 X 35	2,718	0,029	17897089804960
531-1	7897089805311	PRATELEIRA ORGANIZADORA P/ARMÁRIO BAIXA CROMADA	28 X 13 X 20,5	0,388	6	34 X 24 X 38,5	2,624	0,031	17897089805318



**147-4 | Fruteira com 3 Cestas
Desmontável Cromada c/ Tampo
de Madeira e c/ Rodízios cx. c/ 4 pçs**



**1608-9 | Fruteira c/ 2 Cestas
Desmontável Cromada
c/ Tampo de Madeira s/
Rodízios cx. c/ 4 pçs**



**804-6 | Fruteira c/ 2 Cestas
Desmontável Cromada c/ Tampo
de Madeira e c/ Rodízios cx. c/ 4 pçs**



Código	EAN	Descrição	Dimensão (cm)	Peso (kg)	Qt. cx. master	Dimensão cx. master (cm)	Peso cx. master (kg)	Cubagem cx. master (m³)	DUN 14
147-4	7897089801474	FRUTEIRA 3 CESTAS RET. DESM. C/ TAMPO MADEIRA C/ RODÍZIO	34 X 27 X 78	2,852	4	39 X 30 X 81	12,115	0,095	17897089801471
804-6	7897089808046	FRUTEIRA 2 CESTAS RET. DESM. C/ TAMPO MADEIRA C/ RODÍZIO	34 X 27 X 78	2,568	4	39 X 30 X 77	10,710	0,090	17897089808043
1608-9	7897089816089	FRUTEIRA 2 CESTAS DESM. CROMADA C/ TAMPO S/ RODÍZIO	34 X 27 X 69	2,310	4	39 X 30 X 70	10,100	0,082	17897089816086

*Comprimento x Largura x Altura

IR PARA O ÍNDICE

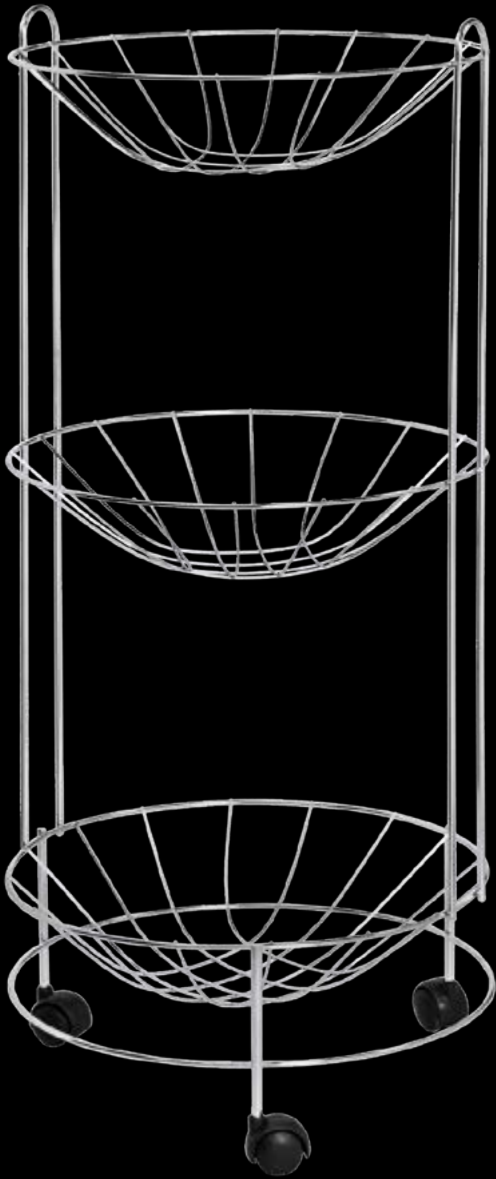

tag

575-5 | Fruteira Redonda
c/ 3 Cestas Cromada c/ 6 pçs

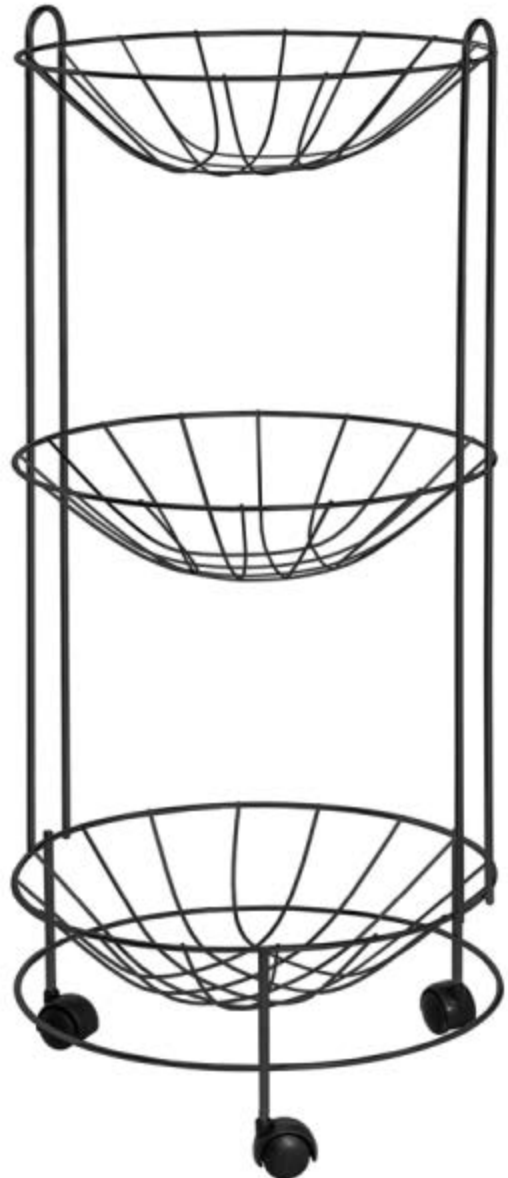

tag

631-8 | Fruteira Redonda
c/ 3 Cestas Black cx. c/ 6 pçs

Código	EAN	Descrição	Dimensão (cm)	Peso (kg)	Qt. cx. master	Dimensão cx. master (cm)	Peso cx. master (kg)	Cubagem cx. master (m³)	DUN 14
575-5	7897089805755	FRUTEIRA TRIPLA REDONDA REFORÇADA CROMADA	30,5 X 30,5 X 71	0,792	6	87 X 39 X 62,5	5,766	0,212	67897089805757
631-8	7897089806318	FRUTEIRA TRIPLA REDONDA REFORÇADA BLACK	30,5 X 30,5 X 71	0,796	6	87 X 39 X 62,5	5,914	0,212	17897089806315



683-7 | Fruteira de Mesa Redonda Luxo Cromada cx. c/ 10 pçs



684-4 | Fruteira de Mesa Redonda Luxo Black cx. c/ 10 pçs

tag

Passerini



669-1 | Fruteira Redonda de Mesa "Prática" Cromada cx. c/ 10 pçs



978-4 | Fruteira Redonda de Mesa "Prática" Black cx. c/ 10 pçs

tag

Passerini



601-1 | Fruteira Redonda 2 Cestas Desmontável Cromada cx. c/ 6 pçs

Código	EAN	Descrição	Dimensão (cm)	Peso (kg)	Qt. cx. master	Dimensão cx. master (cm)	Peso cx. master (kg)	Cubagem cx. master (m³)	DUN 14
601-1	7897089806011	FRUTEIRA REDONDA 2 CESTAS DESMONTÁVEL CROMADA	29,5 X 30 X 34,5	0,640	6	51,5 X 24 X 42	4,274	0,052	67897089806013
669-1	7897089806691	FRUTEIRA REDONDA DE MESA 1 CESTA CROMADA	11 X 29 X 29	0,110	10	42 X 32 X 33	1,410	0,044	17897089806698
683-7	7897089806837	FRUTEIRA DE MESA REDONDA LUXO CROMADA	32 X 30 X 17	0,330	10	41 X 26,5 X 32	3,650	0,035	17897089806834
684-4	7897089806844	FRUTEIRA DE MESA REDONDA LUXO BLACK	32 X 30 X 17	0,336	10	41 X 26,5 X 32	3,712	0,035	17897089806841
978-4	7897089809784	FRUTEIRA REDONDA DE MESA 1 CESTA BLACK	11 X 29 X 29	0,110	10	42 X 32 X 33	1,410	0,044	17897089809781

*Comprimento x Largura x Altura

IR PARA O ÍNDICE



810-7 | Suporte c/ 15 Vidros de Tempero Cromado cx. c/ 2 pçs

★ ★ 15 FRASCOS DE VIDRO

● CAPACIDADE FRASCOS 100ml



832-9 | Suporte c/ 15 Vidros de Tempero Black cx. c/ 2 pçs



solapa

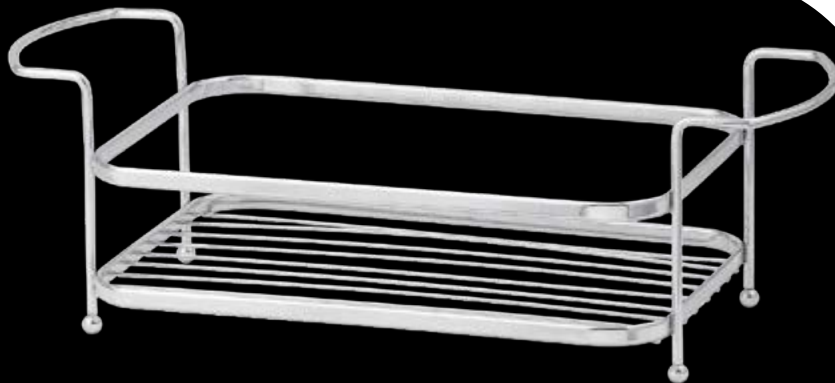

809-1 | Suporte p/ Tempero Laminado Grande Cromado cx. c/ 4 pçs



834-3 | Suporte p/ Tempero Grande Laminado Black cx. c/ 4 pçs



solapa

Código	EAN	Descrição	Dimensão (cm)	Peso (kg)	Qt. cx. master	Dimensão cx. master (cm)	Peso cx. master (kg)	Cubagem cx. master (m³)	DUN 14
809-1	7897089808091	SUPORTE P/TEMPEROS LAMINADO GRANDE CROMADO	32,5 X 14 X 10,5	0,366	4	31 X 31 X 21	1,724	0,020	17897089808098
810-7	7897089808107	SUPORTE C/15 VIDROS DE TEMPERO CROMADO	32,5 X 14 X 12,5	1,868	2	31 X 31 X 16,5	3,988	0,016	17897089808104
832-9	7897089808329	SUPORTE C/15 VIDROS DE TEMPERO BLACK	32,5 X 14 X 12,5	1,880	2	31 X 31 X 16,5	4,012	0,016	17897089808326
834-3	7897089808343	SUPORTE P/TEMPEROS LAMINADO GRANDE BLACK	32,5 X 14 X 10,5	0,370	4	31 X 31 X 21	1,724	0,020	17897089808340

☆☆ **9 FRASCOS DE VIDRO**
 ● CAPACIDADE FRASCOS 100ml



541-0 | Suporte c/ 9 Vidros de Tempero Cromado cx. c/ 4 pçs



635-6 | Suporte c/ 9 Vidros de Tempero Black cx. c/ 4 pçs

solapa



808-4 | Suporte p/ Tempero Laminado Cromado cx. c/ 5 pçs

Imagem meramente ilustrativa. Não acompanha vidros de tempero.



833-6 | Suporte p/ Tempero Laminado Black cx. c/ 5 pçs

Código	EAN	Descrição	Dimensão (cm)	Peso (kg)	Qt. cx. master	Dimensão cx. master (cm)	Peso cx. master (kg)	Cubagem cx. master (m³)	DUN 14
541-0	7897089805410	SUPORE C/ 9 VIDROS DE TEMPERO CROMADO	23,5 X 14 X 12,5	1,196	4	31 X 31 X 16,5	5,054	0,016	17897089805417
635-6	7897089806356	SUPORE C/ 9 VIDROS DE TEMPERO BLACK	23,5 X 14 X 12,5	1,174	4	31 X 31 X 16,5	4,970	0,016	17897089806353
808-4	7897089808084	SUPORE P/ TEMPEROS LAMINADO CROMADO	23,5 X 14 X 10,5	0,288	5	31 X 31 X 21	1,690	0,020	17897089808081
833-6	7897089808336	SUPORE P/ TEMPEROS LAMINADO BLACK	23,5 X 14 X 10,5	0,290	5	31 X 31 X 21	1,690	0,020	17897089808333

*Comprimento x Largura x Altura

IR PARA O ÍNDICE



0710-0 | Cromado cx. c/ 6 pçs

SUPORE C/ 6 VIDROS P/TEMPEROS C/ ALÇA



0940-1 | Black cx. c/ 6 pçs

6 FRASCOS DE VIDRO

● CAPACIDADE FRASCOS 100ml



0707-0 | Cromado cx. c/ 4 pçs

SUPORE C/ 6 VIDROS P/TEMPEROS



0747-6 | Black cx. c/ 4 pçs

● CAPACIDADE FRASCOS 100ml



901-2 | Suporte Cromado p/ Rolo com 4 Potes Plásticos Tampas Cores cx. c/ 6 pçs



● CAPACIDADE FRASCOS 100ml



563-2 | Suporte p/ Condimentos Cromado com 5 Potes Plásticos com Tampas Cores cx. c/ 10 pçs

Código	EAN	Descrição	Dimensão (cm)	Peso (kg)	Qt. cx. master	Dimensão cx. master (cm)	Peso cx. master (kg)	Cubagem cx. master (m³)	DUN 14
563-2	7897089805632	SUPORE P/ CONDIM. CROM. C/ 5 POTES PLAST. C/ TAMPAS CORES	32 X 8 X 10	0,228	10	41,5 X 41,5 X 20,5	2,688	0,035	17897089805639
707-0	7897089807070	SUPORE CROMADO C/ 6 VIDROS P/ TEMPERO	22,5 X 10 X 10,5	0,224	4	31 X 31 X 21	1,180	0,020	17897089807077
710-0	7897089807100	SUPORE CROMADO C/ ALÇA C/ 6 VIDROS P/ TEMPERO	15 X 10 X 19	0,188	6	31 X 31 X 21	1,238	0,020	17897089807107
747-6	7897089807476	SUPORE BLACK C/ 6 VIDROS P/ TEMPERO	22,5 X 10 X 10,5	0,224	4	31 X 31 X 21	1,180	0,020	17897089807473
901-2	7897089809012	SUPORE CROMADO P/ ROLO C/ 4 POTES PLÁSTICOS TAMPAS CORES	27,2 X 7,5 X 21,5	0,328	6	34 X 24 X 38,5	2,238	0,031	17897089809019
940-1	7897089809401	SUPORE BLACK C/ ALÇA C/ 6 VIDROS P/ TEMPERO	15 X 10 X 19	0,188	6	31 X 31 X 21	1,238	0,020	17897089809408



caixa litografada



265-5 | Kitchen Set 1 - Triplo (Prateleira/ Escorredor / Suporte Rolo) cx. c/ 4 pçs



caixa litografada



266-2 | Kitchen Set 2 - Duplo (Suporte Rolo/ Prateleira) cx. c/ 4 pçs



caixa litografada



268-6 | Kitchen Set 4 - Duplo (Escorredor/ Prateleira) cx. c/ 4 pçs



caixa litografada



267-9 | Kitchen Set 3 - Duplo (Suporte Rolo/ Escorredor) cx. c/ 4 pçs



caixa litografada



780-3 | Kitchen Set Duplo (Suporte Rolo + Escorredor) Black cx. c/ 4 pçs

Código	EAN	Descrição	Dimensão (cm)	Peso (kg)	Qt. cx. master	Dimensão cx. master (cm)	Peso cx. master (kg)	Cubagem cx. master (m³)	DUN 14
265-5	7897089802655	KITCHEN SET TRIPLO 1 (ESCORREDOR / SUP. ROLO / PRATELEIRA)	141 X 24 X 40	3,258	4	64 X 51 X 41,5	14,160	0,135	47897089802653
266-2	7897089802662	KITCHEN SET DUPLO 2 (SUPORTE P/ ROLOS / PRATELEIRA)	71,5 X 17 X 40	1,902	4	64 X 51 X 41,5	8,505	0,135	47897089802660
267-9	7897089802679	KITCHEN SET DUPLO 3 (ESCORREDOR / SUPORTE P/ ROLOS)	71,5 X 24 X 40	2,258	4	64 X 51 X 41,5	9,840	0,135	47897089802677
268-6	7897089802686	KITCHEN SET DUPLO 4 (ESCORREDOR / PRATELEIRA)	71,5 X 24 X 40	2,518	4	64 X 51 X 41,5	10,975	0,135	47897089802684
780-3	7897089807803	KITCHENSET DUPLO (SUP. ROLO + ESCORR.) - BLACK	71,5 X 24 X 40	2,398	4	64 X 51 X 41,5	10,505	0,135	17897089807800

*Comprimento x Largura x Altura

IR PARA O ÍNDICE



caixa litografada



308-9 | Kit Prático 4
(Suporte p/ Rolos)
cx. c/ 4 pçs



caixa litografada



316-4 | Kit Prático 5 (Prateleira Dupla) cx. c/ 4 pçs



caixa litografada



317-1 | Kit Prático 6 (Escorredor de Louças) cx. c/ 4 pçs

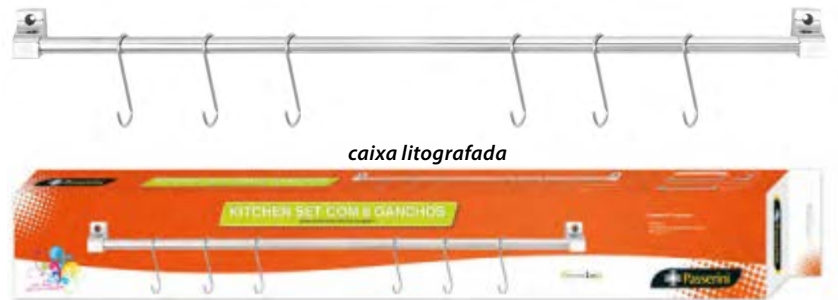

caixa litografada



143-6 | Kitchen Set "Barra c/ 6 Ganchos" cx. c/ 6 pçs



caixa litografada



779-7 | Kitchen Set Barra Black c/ 6 Ganchos cx. c/ 6 pçs

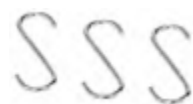

477-2 | Cj. c/ 3 Ganchos Cromado cx. c/ 6 pçs



778-0 | Cj. c/ 3 Ganchos Black cx. c/ 6 pçs

Código	EAN	Descrição	Dimensão (cm)	Peso (kg)	Qt. cx. master	Dimensão cx. master (cm)	Peso cx. master (kg)	Cubagem cx. master (m³)	DUN 14
143-6	7897089801436	KITCHEN SET BARRA C/ 6 GANCHOS C/ CAIXA LITOGRAFADA	71 X 4 X 8	0,372	6	77 X 13,5 X 36,5	2,636	0,038	17897089801433
308-9	7897089803089	KITCHENSET PRATICO 4 (SUP. ROLOS E 3 GANCHOS)	61 x 16 x 40	1,028	4	64,5 X 37,5 X 40	4,900	0,114	17897089803086
316-4	7897089803164	KITCHENSET PRATICO 5 (PRATELEIRA E 3 GANCHOS)	61 x 17 x 40	1,326	4	64,5 X 37,5 X 47	6,015	0,114	17897089803161
317-1	7897089803171	KITCHENSET PRATICO 6 (ESCORREDOR E 3 GANCHOS)	61 x 24 x 40	1,692	4	64,5 X 37,5 X 47	7,480	0,114	17897089803178
477-2	7897089804772	CONJ. C/ 3 GANCHOS AVULSOS KITCHENSET	5 X 0,3 X 8	0,038	6	19,5 X 15,5 X 12	0,328	0,004	17897089804779
778-0	7897089807780	CONJ. C/ 3 GANCHOS AVULSO P/KITCHENSET - BLACK	5 X 0,3 X 8	0,038	6	19,5 X 15,5 X 12	0,328	0,004	17897089807787
779-7	7897089807797	KITCHEN SET BARRA BLACK C/ 6 GANCHOS C/ CAIXA LITOGRAFADA	71 X 4 X 8	0,378	6	77 X 13,5 X 36,5	2,656	0,038	17897089807794



264-8 | Suporte Rolos Triplo Cromado cx. c/ 12 pçs



752-0 | Suporte Rolos Triplo Black cx. c/ 12 pçs



700-1 | Porta Rolos Triplo "Prático" Cromado cx. c/ 12 pçs

solapa



1566-2 | Porta Rolos Triplo "Prático" Black cx. c/ 12 pçs

Código	EAN	Descrição	Dimensão (cm)	Peso (kg)	Qt. cx. master	Dimensão cx. master (cm)	Peso cx. master (kg)	Cubagem cx. master (m³)	DUN 14
264-8	7897089802648	SUPORTE DE ROLOS TRIPLO P/ PAREDE CROMADO	24 X 13 X 25	0,190	12	51,5 X 24 X 42	2,702	0,052	17897089802645
700-1	7897089807001	PORTA ROLO TRIPLO "PRÁTICO" CROMADO	21 X 7,5 X 33	0,015	12	34 X 24 X 38,5	1,980	0,031	17897089807008
752-0	7897089807520	SUPORTE DE ROLOS TRIPLO P/ PAREDE BLACK	24 X 13 X 25	0,194	12	51,5 X 24 X 42	2,748	0,052	17897089807527
1566-2	7897089815662	PORTA ROLO TRIPLO "PRÁTICO" BLACK	21 X 7,5 X 33	0,015	12	34 X 24 X 38,5	1,980	0,031	17897089815669



445-1 | Porta Detergente Organizador p/ Pia Cromado cx. c/ 8 pçs



772-8 | Porta Detergente Organizador p/ Pia Black cx. c/ 8 pçs



1571-6 | Porta Detergente Organizador p/ Pia "Prático" Cromado cx. c/ 6 pçs



127-6 | Suporte para Xícaras "Torre" Cromado cx. c/ 12 pçs



753-7 | Suporte para Xícaras "Torre" Black cx. c/ 12 pçs

Código	EAN	Descrição	Dimensão (cm)	Peso (kg)	Qt. cx. master	Dimensão cx. master (cm)	Peso cx. master (kg)	Cubagem cx. master (m³)	DUN 14
127-6	7897089801276	PORTA XÍCARAS VERTICAL CROMADO	15 X 13 X 30	0,120	12	31 X 31 X 21	1,706	0,020	17897089801273
445-1	7897089804451	ARAMADO ORGANIZADOR P/ PIA CROMADO	20 X 9 X 13,5	0,138	8	39 X 31 X 10,5	1,266	0,013	17897089804458
753-7	7897089807537	PORTA XÍCARAS VERTICAL BLACK	15 X 13 X 30	0,122	12	31 X 31 X 21	1,718	0,020	17897089807534
772-8	7897089807728	SUP. P/ DETERGENTE BLACK	20 X 9 X 13,5	0,136	8	39 X 31 X 10,5	1,300	0,013	17897089807725
1571-6	7897089815716	PORTA DETERGENTE ORGANIZADOR P/ PIA PRATICO CROMADO	28,5 X 9 X 8,5	0,141	6	39 X 31 X 10,5	1,198	0,013	17897089815713

357-7 | Suporte p/ Rolo Vertical Cromado cx. c/ 12 pçs



636-3 | Suporte p/ Rolo Vertical Black cx. c/ 12 pçs



768-1 | Porta Rolo Vertical "Prático" Cromado cx. c/12 pçs



769-8 | Porta Rolo Vertical "Prático" Black cx. c/ 12 pçs



879-4 | Suporte p/ Rolo Vertical Laminado Cromado cx. c/ 6 pçs



637-0 | Suporte p/ Rolo Vertical Laminado Black cx. c/ 6 pçs



Código	EAN	Descrição	Dimensão (cm)	Peso (kg)	Qt. cx. master	Dimensão cx. master (cm)	Peso cx. master (kg)	Cubagem cx. master (m³)	DUN 14
357-7	7897089803577	SUPORE P/ ROLO VERTICAL CROMADO	14,5 X 11 X 28	0,172	12	31 X 31 X 21	2,350	0,020	17897089803574
636-3	7897089806363	SUPORE P/ ROLO VERTICAL BLACK	14,5 X 11 X 28	0,178	12	31 X 31 X 21	2,404	0,020	17897089806360
637-0	7897089806370	SUPORE P/ ROLO VERTICAL LAMINADO BLACK - SEM CAIXA	13 X 13 X 29,5	0,262	6	31 X 31 X 21	1,854	0,020	17897089806377
768-1	7897089807681	PORTA ROLO VERTICAL "PRÁTICO" CROMADO	15 X 13,5 X 31	0,150	12	31 X 31 X 21	2,050	0,020	17897089807688
769-8	7897089807698	PORTA ROLO VERTICAL "PRÁTICO" BLACK	15 X 13,5 X 31	0,156	12	31 X 31 X 21	2,078	0,020	17897089807695
879-4	7897089808794	SUPORE P/ ROLO VERTICAL LAMINADO CROMADO - SEM CAIXA	13 X 13 X 29,5	0,260	6	31 X 31 X 21	1,820	0,020	17897089808791

*Comprimento x Largura x Altura

IR PARA O ÍNDICE



**490-1 | Suporte
c/ Coador Plástico**
cx. c/ 10 pçs

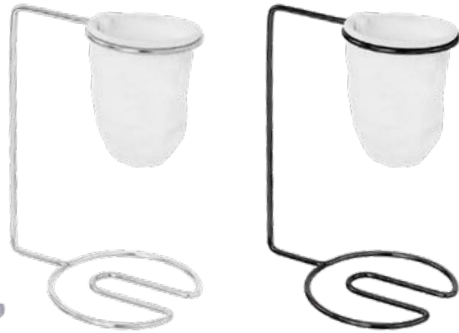

**679-0 | Suporte p/
Coador Mini Cromado**
cx. c/ 20 pçs

**667-7 | Suporte p/
Coador Mini Black**
cx. c/ 20 pçs



solapa



**811-4 | Porta
Talheres "Prático"**
Cromado Preto
cx. c/ 8 pçs



**510-6 | Porta Chaves
5 Ganchos "Casinha"**
Cromado cx. c/ 24 pçs



**638-7 | Porta Chaves
5 Ganchos "Casinha"**
Black cx. c/ 24 pçs



**966-1 | Cesto p/
Fritura Estanhado**
cx. c/ 12 pçs



**056-9 | Descanso
p/ Panela Redondo
Cromado Individual**
cx. c/ 30 pçs



**131-3 | Porta-
Chaves "Chave"**
Cromado
cx. c/ 24 pçs



**349-2 | Porta Guardanapos
Cromado** cx. c/ 25 pçs



**644-8 | Porta Guardanapos
Black** cx. c/ 25 pçs

Código	EAN	Descrição	Dimensão (cm)	Peso (kg)	Qt. cx. master	Dimensão cx. master (cm)	Peso cx. master (kg)	Cubagem cx. master (m³)	DUN 14
056-9	7897089800569	DESCANSO P/ PANELA RED. CROMADO INDIVIDUAL	20 X 20 X 1,5	0,050	30	39 X 31 X 10,5	1,684	0,013	67897089800561
131-3	7897089801313	PORTA CHAVES 5 GANCHOS "CHAVINHA" CROMADO	23,8 X 3 X 11	0,050	24	19,5 X 15,5 X 23,5	1,320	0,007	17897089801310
349-2	7897089803492	PORTA GUARDANAPOS CROMADO	12,5 X 8 X 8	0,060	25	39 X 31 X 10,5	1,716	0,013	57897089803497
490-1	7897089804901	SUPORTE P/ COADOR CROMADO C/ PLÁSTICO	16 X 13 X 26,5	0,266	10	41 X 26,5 X 37	2,990	0,040	17897089804908
510-6	7897089805106	PORTA CHAVES 5 GANCHOS "CASINHA" CROMADO	19 X 3,5 X 18,6	0,054	24	19,5 X 15,5 X 23,5	1,380	0,007	67897089805108
638-7	7897089806387	PORTA CHAVES 5 GANCHOS "CASINHA" BLACK	19 X 3,5 X 18,6	0,054	24	19,5 X 15,5 X 23,5	1,406	0,007	17897089806384
644-8	7897089806448	PORTA GUARDANAPOS BLACK	12,5 X 8 X 8	0,064	25	39 X 31 X 10,5	1,750	0,013	17897089806445
667-7	7897089806677	ARAMADO SUPORTE C/ COADOR MINI - BLACK	11,5 X 9 X 15,5	0,052	20	45 X 31 X 12	1,332	0,017	17897089806674
679-0	7897089806790	SUPORTE P/ COADOR MINI CROMADO	11,5 X 9 X 15,5	0,052	20	45 X 31 X 12	1,332	0,017	17897089806797
811-4	7897089808114	PORTA TALHERES "PRÁTICO" CROMADO - PRETO	15 X 7,5 X 27	0,202	8	31 X 31 X 21	1,872	0,020	17897089808111
966-1	7897089809661	CESTO P/ FRITURA ESTANHADO	37 X 21,5 X 8	0,142	12	45 X 31 X 12	1,958	0,017	17897089809668



542-7 | Suporte Cromado Triplo p/ Cápsulas **Dolce Gusto** cx. c/ 6 pçs
• 15 cápsulas



543-4 | Suporte Cromado Triplo p/ Cápsulas **Nespresso** cx. c/ 6 pçs
• 21 cápsulas



544-1 | Suporte Cromado Triplo p/ Cápsulas **3 Corações** cx. c/ 6 pçs
• 18 cápsulas

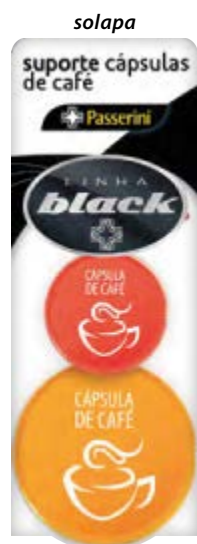

711-7 | Suporte Black Triplo para Cápsulas **Dolce Gusto** cx. c/6 pçs



712-4 | Suporte Black Triplo para Cápsulas **Nespresso** cx. c/6 pçs



713-1 | Suporte Black Triplo para Cápsulas **3 Corações** cx. c/6 pçs

Código	EAN	Descrição	Dimensão (cm)	Peso (kg)	Qt. cx. master	Dimensão cx. master (cm)	Peso cx. master (kg)	Cubagem cx. master (m³)	DUN 14
542-7	7897089805427	SUORTE CROMADO P/CÁPSULAS DOLCE GUSTO TRIPLIO	17 X 17 X 28,5	0,452	6	41 X 26 X 31	2,998	0,033	17897089805424
543-4	7897089805434	SUORTE CROMADO P/CÁPSULAS NESPRESSO TRIPLIO	15,5 X 15,5 X 28,5	0,442	6	41 X 26 X 31	2,986	0,033	17897089805431
544-1	7897089805441	SUORTE CROMADO P/CÁPSULAS TRÊS CORAÇÕES TRIPLIO	17 X 17 X 28,5	0,450	6	41 X 26 X 31	3,042	0,033	17897089805448
711-7	7897089807117	SUORTE BLACK P/CÁPSULAS DOLCE GUSTO TRIPLIO	17 X 17 X 28,5	0,450	6	41 X 26 X 31	3,014	0,033	17897089807114
712-4	7897089807124	SUORTE BLACK P/CÁPSULAS NESPRESSO TRIPLIO	15,5 X 15,5 X 28,5	0,442	6	41 X 26 X 31	3,002	0,033	17897089807121
713-1	7897089807131	SUORTE BLACK P/CÁPSULAS TRÊS CORAÇÕES TRIPLIO	17 X 17 X 28,5	0,452	6	41 X 26 X 31	3,056	0,033	17897089807138

*Comprimento x Largura x Altura

IR PARA O ÍNDICE



solapa



820-6 | Suporte p/ 32
Cápsulas **Dolce Gusto**
Cromado cx. c/ 6 pçs



822-0 | Suporte p/ 32
Cápsulas **3 Corações**
Cromado cx. c/ 6 pçs



837-4 | Suporte p/ 32
Cápsulas **Dolce Gusto**
Black cx. c/ 6 pçs



839-8 | Suporte p/ 32
Cápsulas **3 Corações**
Black cx. c/ 6 pçs



tag



240-2 | Suporte p/
Garrafa de Vinho
4,20 mm Cromado
cx. c/ 6 pçs



758-2 Suporte
p/ Garrafa de
Vinho 4,20 mm
Black cx. c/ 6 pçs

Código	EAN	Descrição	Dimensão (cm)	Peso (kg)	Qt. cx. master	Dimensão cx. master (cm)	Peso cx. master (kg)	Cubagem cx. master (m³)	DUN 14
240-2	7897089802402	PORTA VINHO CROMADO	26 X 12 X 24	0,176	6	31 X 31 X 21	1,312	0,020	67897089802404
758-2	7897089807582	PORTA VINHO BLACK	26 X 12 X 24	0,176	6	31 X 31 X 21	1,308	0,020	17897089807589
820-6	7897089808206	SUPORTE P/ 32 CÁPSULAS DOLCE GUSTO TRIPLIO CROMADO	22,5 X 21,5 X 31,5	0,440	6	41 X 26,5 X 23	2,984	0,025	17897089808203
822-0	7897089808220	SUPORTE P/ 32 CÁPSULAS TRÊS CORAÇÕES TRIPLIO CROMADO	21 X 19 X 28,5	0,388	6	34 X 24 X 20	2,594	0,016	17897089808227
837-4	7897089808374	SUPORTE P/ 32 CÁPSULAS DOLCE GUSTO TRIPLIO BLACK	22,5 X 21,5 X 31,5	0,440	6	41 X 26,5 X 23	2,984	0,025	17897089808371
839-8	7897089808398	SUPORTE P/ 32 CÁPSULAS TRÊS CORAÇÕES TRIPLIO BLACK	21 X 19 X 28,5	0,388	6	34 X 24 X 20	2,594	0,016	17897089808395

PORTA-COPOS

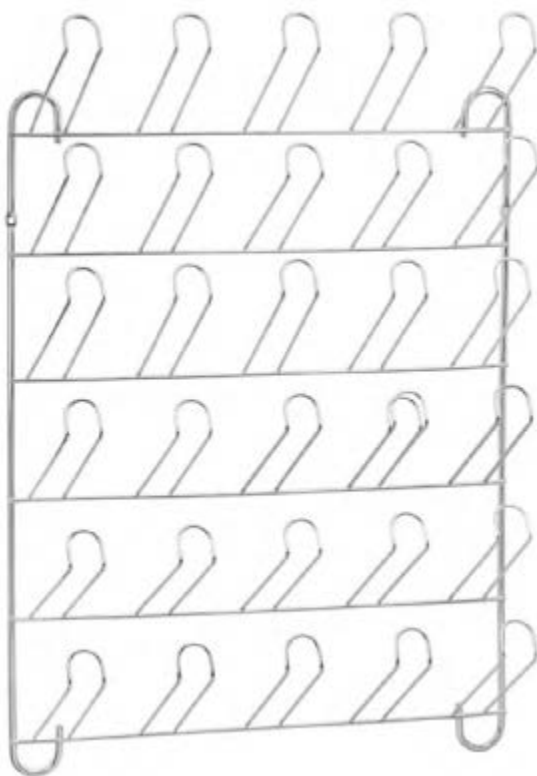

509-0 | Suporte p/ 30 copos Cromado Reforçado cx. c/ 10 pçs



124-5 | Suporte p/ 20 copos Cromado Reforçado cx. c/ 10 pçs

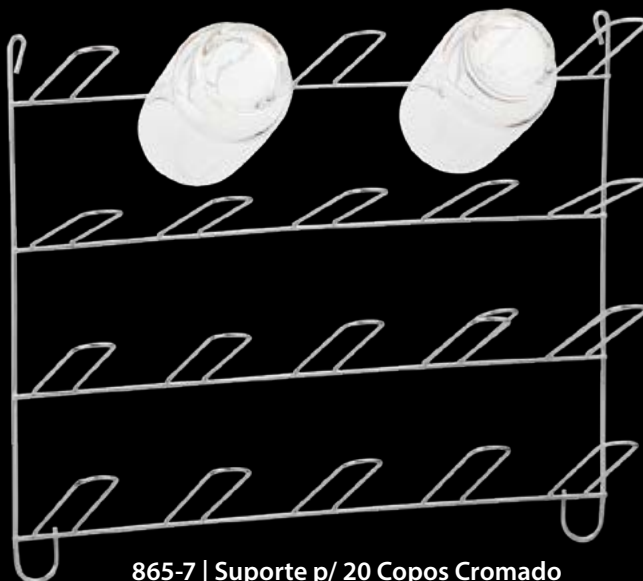

865-7 | Suporte p/ 20 Copos Cromado cx. c/ 12 pçs

Código	EAN	Descrição	Dimensão (cm)	Peso (kg)	Qt. cx. master	Dimensão cx. master (cm)	Peso cx. master (kg)	Cubagem cx. master (m³)	DUN 14
124-5	7897089801245	PORTA COPOS 20 LUGARES CROM. REFORÇADO C/PARAF. E BUCHAS	29 X 12 X 44	0,582	10	53 X 37,5 X 40,5	6,365	0,080	17897089801242
509-0	7897089805090	PORTA COPOS 30 LUGARES REFORÇADO CROM. C/PARAF. E BUCHAS	38 X 12 X 54	0,808	10	64,5 X 37,5 X 42	8,825	0,102	17897089805097
865-7	7897089808657	PORTA COPOS 20 LUGARES CROMADO	37,5 X 10,5 X 34	0,376	12	41,5 X 41,5 X 16	4,948	0,028	17897089808654

*Comprimento x Largura x Altura

IR PARA O ÍNDICE

PORTA-COPOS



006-4 | Suporte para 6 Copos Cromado cx. c/ 15 pçs



754-4 | Suporte para 6 Copos Black cx. c/ 15 pçs



123-8 | Suporte para 8 Copos Cromado cx. c/ 15 pçs

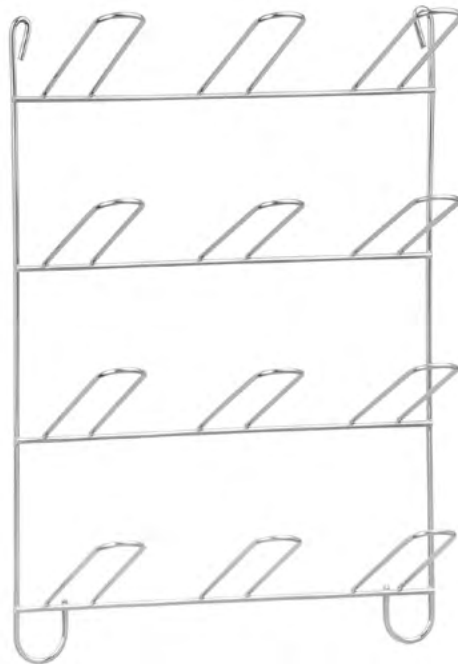
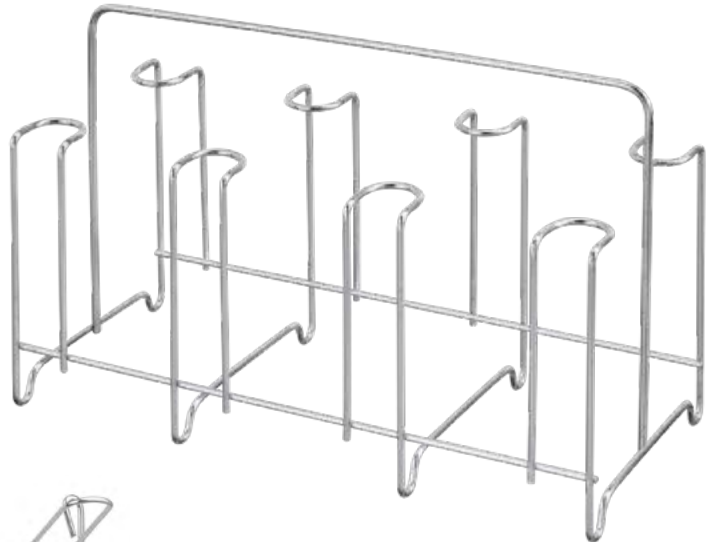

251-8 | Suporte para 12 Copos Cromado cx. c/ 12 pçs

Código	EAN	Descrição	Dimensão (cm)	Peso (kg)	Qt. cx. master	Dimensão cx. master (cm)	Peso cx. master (kg)	Cubagem cx. master (m³)	DUN 14
006-4	7897089800064	PORTA COPOS 6 LUGARES CROMADO	18 X 12 X 19	0,154	15	47 X 21 X 47,5	2,660	0,047	77897089800063
123-8	7897089801238	PORTA COPOS 8 LUGARES CROMADO	27 X 12 X 18	0,198	15	47 X 34 X 48,5	3,514	0,078	17897089801235
251-8	7897089802518	PORTA COPOS 12 LUGARES P/ PAREDE CROMADO	22,5 X 11 X 32,5	0,244	12	34 X 24 X 20	3,186	0,016	17897089802515
754-4	7897089807544	PORTA COPOS 6 LUGARES BLACK	18 X 12 X 19	0,154	15	47 X 21 X 47,5	2,660	0,047	17897089807541

LAMINADO



16 PRATOS

8 PORTA COPOS

PORTA TALHERES INOX

791-9 | Escorredor de Louça Cama "Laminado" Cromado c/ Porta Talheres em Inox cx. c/ 3 pçs

solapa

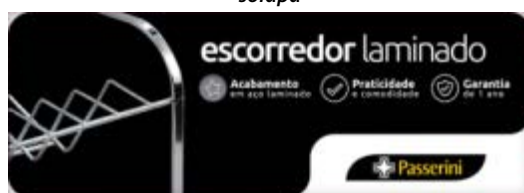

16 PRATOS

8 PORTA COPOS

PORTA TALHERES PLÁSTICO LUXO



365-2 | Escorredor de Louça Cama "Laminado" Cromado c/ Porta Talheres Plástico Luxo cx. c/ 3 pçs

Código	EAN	Descrição	Dimensão (cm)	Peso (kg)	Qt. cx. master	Dimensão cx. master (cm)	Peso cx. master (kg)	Cubagem cx. master (m³)	DUN 14
365-2	7897089803652	ESCORR. LOUÇAS CAMA LAMINADO CROM. C/ P.TALH. PLAST.	45 X 43 X 18,5	0,946	3	53 X 37,5 X 40,5	3,410	0,080	17897089803659
791-9	7897089807919	ESCORR. LOUÇAS CAMA LAMINOX CROM. C/ P. TALH. INOX	45 X 42 X 18,5	1,078	3	53 X 37,5 X 40,5	3,744	0,080	17897089807916

*Comprimento x Largura x Altura

IR PARA O ÍNDICE

LAMINADO

 **16** PRATOS

 **8** PORTA COPOS

545-8 | Escorredor de Louça Cama "Laminado" Cromado
cx. c/ 3 pçs

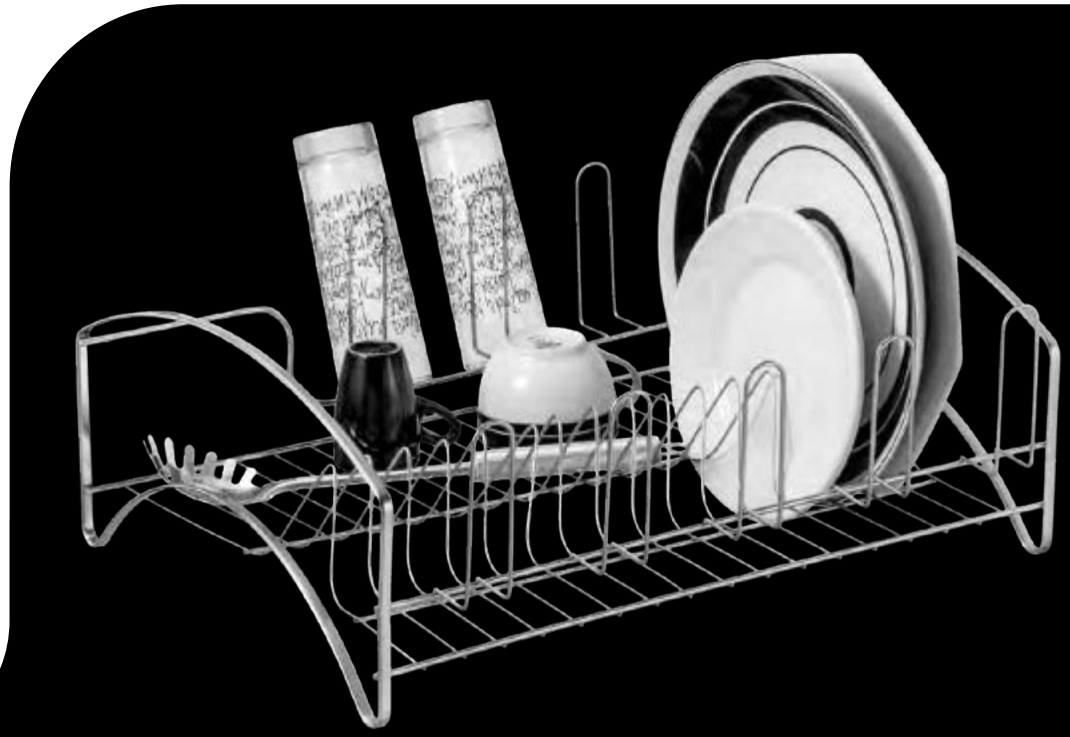

solapa

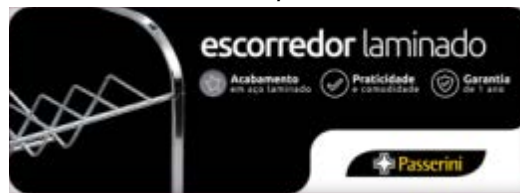

 **16** PRATOS

 **8** PORTA COPOS

639-4 | Escorredor de Louça Cama "Laminado" Black
cx. c/ 3 pçs

Código	EAN	Descrição	Dimensão (cm)	Peso (kg)	Qt. cx. master	Dimensão cx. master (cm)	Peso cx. master (kg)	Cubagem cx. master (m³)	DUN 14
545-8	7897089805458	ESCORREDOR DE LOUÇAS CAMA LAMINADO CROMADO	45 X 40,5 X 18,5	0,870	3	53 X 37,5 X 40,5	3,124	0,080	17897089805455
639-4	7897089806394	ESCORREDOR DE LOUÇAS CAMA LAMINADO BLACK	45 X 40 X 18,5	0,878	3	53 X 37,5 X 40,5	3,174	0,080	17897089806391

IR PARA O ÍNDICE

*Comprimento x Largura x Altura

ESCORREDORES LAMINADOS



 **16** PRATOS

 **5** PORTA COPOS

 PORTA TALHERES INOX

solapa

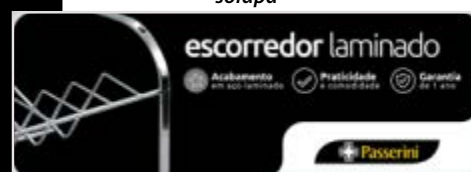

790-2 | Escorredor de Louças Duplo Laminado Cromado c/ Porta Talheres Inox cx. c/ 4 pçs

 **16** PRATOS

 **5** PORTA COPOS

 PORTA TALHERES PLÁSTICO LUXO

solapa



363-8 | Escorredor de Louças Duplo Laminado Cromado c/ Porta Talheres Plástico cx. c/ 4 pçs



Código	EAN	Descrição	Dimensão (cm)	Peso (kg)	Qt. cx. master	Dimensão cx. master (cm)	Peso cx. master (kg)	Cubagem cx. master (m³)	DUN 14
363-8	7897089803638	ESCORR. LOUÇAS DUPLO LAMINADO CROM. C/ P. TALH. PLAST.	41 X 29 X 27	1,036	4	64 X 51 X 41,5	5,058	0,135	17897089803635
790-2	7897089807902	ESCORR. LOUÇAS DUPLO LAMINADO CROM. C/ P. TALH. INOX	40 X 29 X 27	1,150	4	64 X 51 X 41,5	5,520	0,135	17897089807909

*Comprimento x Largura x Altura

IR PARA O ÍNDICE

ESCORREDORES LAMINADOS

 **16** PRATOS

 **5** PORTA COPOS



594-6 | Escorredor de Louças Duplo Laminado Cromado cx. c/ 4 pçs



 **16** PRATOS

 **5** PORTA COPOS



641-7 | Escorredor de Louças Duplo Laminado Black cx. c/ 4 pçs

Código	EAN	Descrição	Dimensão (cm)	Peso (kg)	Qt. cx. master	Dimensão cx. master (cm)	Peso cx. master (kg)	Cubagem cx. master (m³)	DUN 14
594-6	7897089805946	ESCORREDOR DE LOUÇAS DUPLO LAMINADO CROMADO	35,5 X 29 X 27	0,960	4	64 X 51 X 38	4,736	0,124	17897089805943
641-7	7897089806417	ESCORREDOR DE LOUÇAS DUPLO LAMINADO BLACK	35,5 X 29 X 27	0,954	4	64 X 51 X 38	4,754	0,124	17897089806414

ESCORREDORES LAMINADOS



 **12** PRATOS
 **5** PORTA COPOS

818-3 | Escorredor de Louças Cama Laminado "Prático" Cromado
 cx. c/ 6 pçs

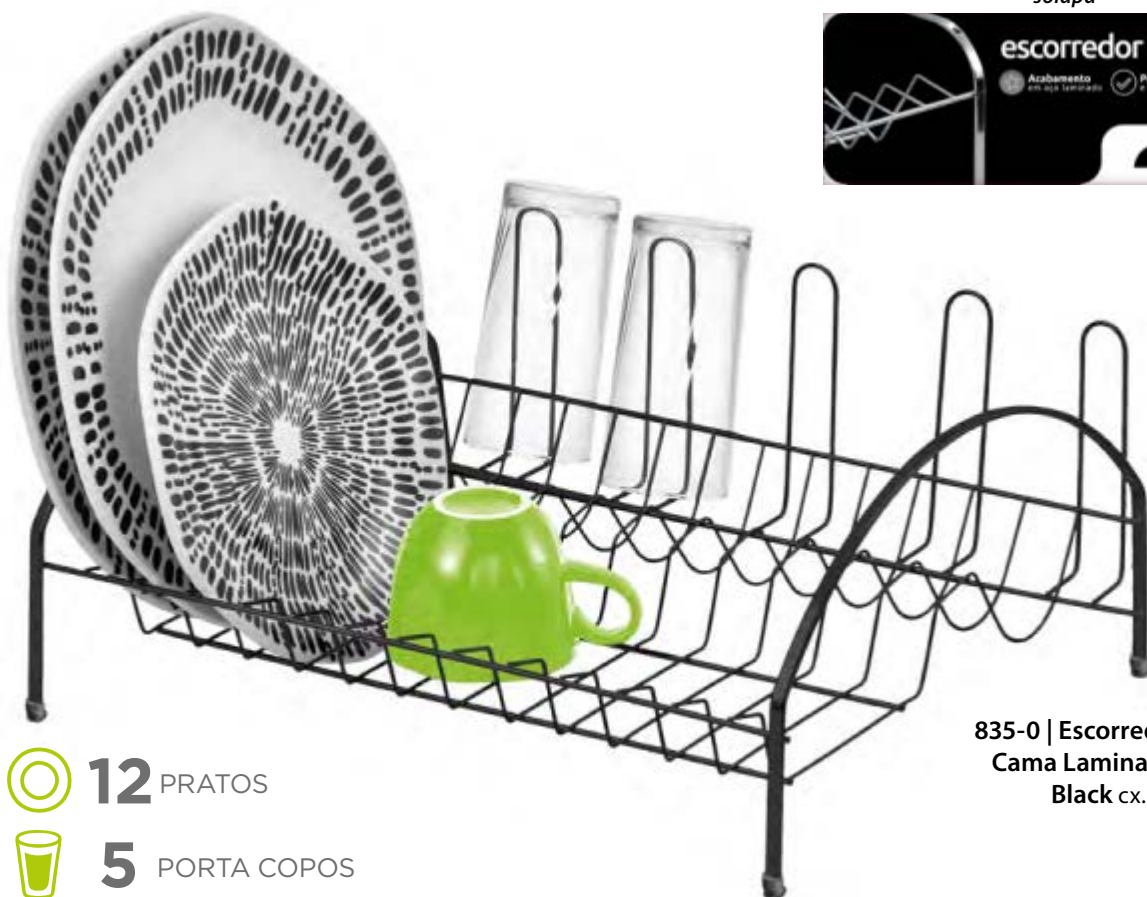

 **12** PRATOS
 **5** PORTA COPOS

835-0 | Escorredor de Louças Cama Laminado "Prático" Black
 cx. c/ 6 pçs

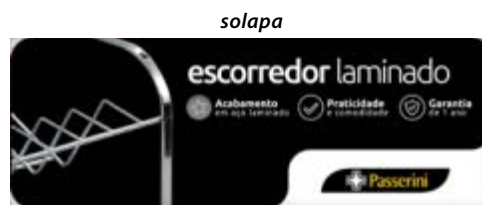

Código	EAN	Descrição	Dimensão (cm)	Peso (kg)	Qt. cx. master	Dimensão cx. master (cm)	Peso cx...	r (m ²)	DUN 14
818-3	7897089808183	ESCORR. LOUÇAS CAMA LAMINADO "PRÁTICO" CROMADO	40,5 X 36 X 17	0,542	6	53 X 37,5 X 40,5	3,842	0,080	17897089808180
835-0	7897089808350	ESCORR. LOUÇAS CAMA LAMINADO "PRÁTICO" BLACK	40,5 X 36 X 17	0,544	6	53 X 37,5 X 40,5	3,836	0,080	17897089808357

*Comprimento x Largura x Altura

IR PARA O ÍNDICE

ESCORREDORES LAMINADOS

 **12** PRATOS

 **5** PORTA COPOS

solapa



817-6 | Escorredor de Louças Duplo Laminado "Prático" Cromado cx. c/ 6 pçs

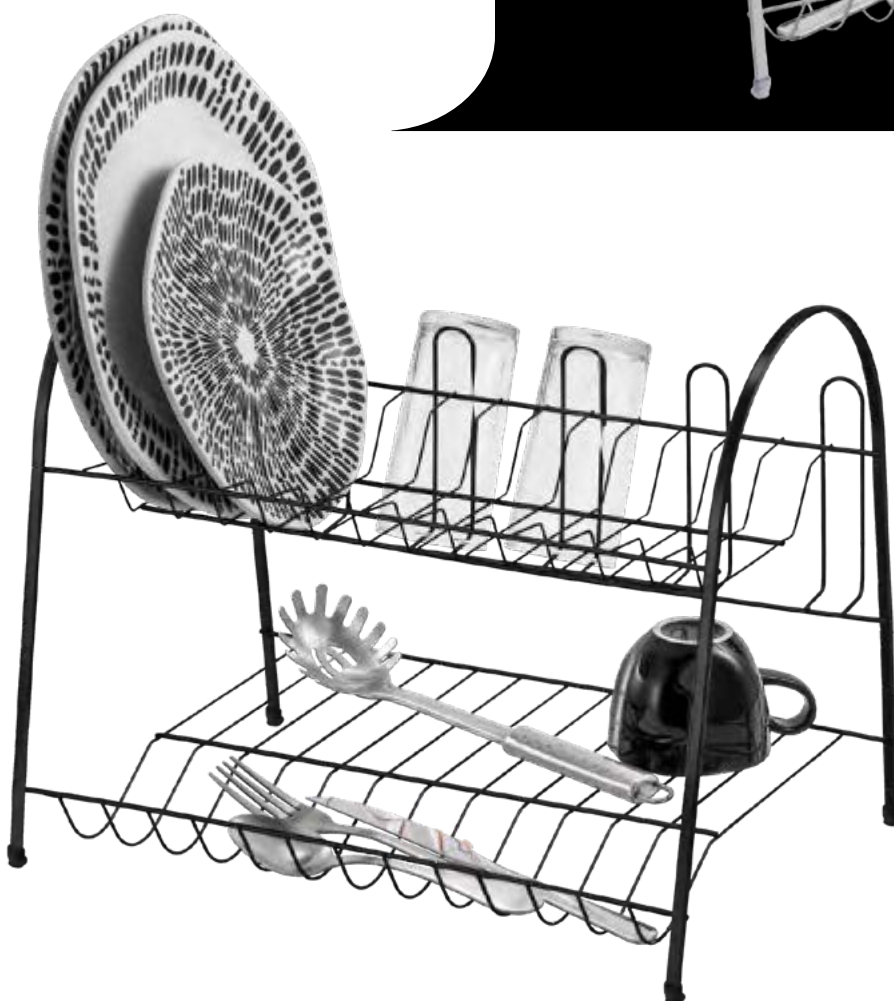

 **12** PRATOS

 **5** PORTA COPOS

solapa



836-7 | Escorredor Duplo Laminado "Prático" Black cx. c/ 6 pçs

Código	EAN	Descrição	Dimensão (cm)	Peso (kg)	Qt. cx. master	Dimensão cx. master (cm)	Peso cx. master (kg)	Cubagem cx. master (m³)	DUN 14
817-6	7897089808176	ESCORR. LOUÇAS DUPLO LAMINADO "PRÁTICO" CROMADO	40,5 X 31 X 33,5	0,724	6	60 X 42 X 73	5,362	0,184	17897089808173
836-7	7897089808367	ESCORR. LOUÇAS DUPLO LAMINADO "PRÁTICO" BLACK	40,5 X 31 X 33,5	0,724	6	60 X 42 X 73	5,440	0,184	17897089808364

ESCORREDORES LAMINADOS

 **20** PRATOS

 PORTA TALHERES



870-1 | Escorredor de Louças X "Laminox" Cromado c/ Porta Talheres Inox c/ cx. Litografada cx. c/ 3 pçs



324-9 | Escorredor de Louças X Laminado Cromado c/ Porta Talheres Plástico Luxo c/ cx. Litografada cx. c/ 3 pçs



682-0 | Escorredor de Louças Cromado Laminado X (sem caixa) cx. c/ 3 pçs

Código	EAN	Descrição	Dimensão (cm)	Peso (kg)	Ot. cx. master	Dimensão cx. master (cm)	Peso cx. master (kg)	Cubagem cx. master (m³)	DUN 14
324-9	7897089803249	ESCORR. LOUÇAS CROM. LAMINADO "X" C/ P. TALH. PLAST	46 X 33 X 25	1,596	3	51,5 X 24 X 42	5,198	0,052	17897089803246
682-0	7897089806820	ESCORREDOR LOUÇAS CROM. LAMINADO "X" - SEM CAIXA	40 X 33 X 25	1,264	3	41,5 X 41,5 X 9	4,200	0,016	17897089806827
870-1	7897089808701	ESCORR. LOUÇAS CROM. LAMINOX "X" C/P. TALH. INOX	46 X 33 X 25	1,724	3	51,5 X 24 X 42	5,606	0,052	17897089808708

*Comprimento x Largura x Altura

IR PARA O ÍNDICE

ESCORREDORES DE PAREDE



☆ ARAME
4,20mm

solapa



450-5 | Escorredor de Louças de Parede "Prático" Cromado c/ Porta Talheres Preto cx. c/ 6 pçs

- 10** PRATOS
- 4** PORTA COPOS
- PORTA TALHERES
- DOBRÁVEL

solapa



756-8 | Escorredor de Louças de Parede "Prático" Black c/ Porta Talheres Preto cx. c/ 6 pçs



Código	EAN	Descrição	Dimensao (cm)	Peso (kg)	Qt. cx. master	Dimensão cx. master (cm)	Peso cx. master (kg)	Cubagem cx. master (m³)	DUN 14
450-5	7897089804505	ESCORREDOR LOUÇAS DE PAREDE "PRÁTICO" CROMADO C/ P. TALH.	38,7 X 24 X 46,5	0,590	6	47 X 34 X 48,5	4,080	0,078	17897089804502
756-8	7897089807568	ESCORREDOR LOUÇAS DE PAREDE "PRÁTICO" BLACK C/ P. TALH.	38,7 X 24 X 46,5	0,590	6	47 X 34 X 48,5	4,080	0,078	17897089807565

ESCORREDORES **P/ PRATOS QUADRADOS**

 **16** PRATOS

 **10** PORTA COPOS

 PORTA TALHERES PLÁSTICO



478-9 | Escorredor de Louças Cama King Cromado
c/ Porta Copos e Porta Talheres de Plástico cx. c/ 6 pçs

 **16** PRATOS

 **10** PORTA COPOS

 PORTA TALHERES PLÁSTICO



659-2 | Escorredor de Louças Cama King Black
c/ Porta Copos e Porta Talheres de Plástico cx. c/ 6 pçs

Código	EAN	DESCRIÇÃO	Dimensão (cm)	Peso (kg)	Qt. cx. master	Dimensão cx. master (cm)	Peso cx. master (kg)	Capacidade cx. master (lit)	UN 14
478-9	7897089804789	ESCORREDOR LOUÇAS CAMA KING CROM. (PRATOS QUADRADOS)	61 X 39 X 19	1,270	6	60 X 42 X 73	8,605	0,184	17897089804786
659-2	7897089806592	ESCORREDOR LOUÇAS CAMA KING BLACK (PRATOS QUADRADOS)	62 X 38 X 20	1,290	6	60 X 42 X 73	8,775	0,184	17897089806599

*Comprimento x Largura x Altura

IR PARA O ÍNDICE

ESCORREDORES P/ PRATOS QUADRADOS

 **14** PRATOS

 **5** PORTA COPOS

 PORTA TALHERES **ARAMADO**



681-3 | Escorredor de Louças Cama Queen Cromado c/ Porta Copos cx. c/ 8 pçs

solapa



 **14** PRATOS

 **5** PORTA COPOS

 PORTA TALHERES **ARAMADO**



1602-7 | Escorredor de Louças Cama Queen Black c/ Porta Copos cx. c/ 8 pçs

Código	EAN	Descrição	Dimensão (cm)	Peso (kg)	Qt. cx. master	Dimensão cx. master (cm)	Peso cx. master (kg)	Cubagem cx. master (m³)	DUN 14
681-3	7897089806813	ESCORREDOR LOUÇAS CAMA QUEEN CROMADO (14 PRATOS)	50,5 X 35 X 18	0,988	8	60 X 42 X 73	8,925	0,184	17897089806810
1602-7	7897089816027	ESCORREDOR LOUÇAS CAMA QUEEN BLACK (14 PRATOS)	50,5 X 35 X 18	0,988	8	60 X 42 X 73	8,925	0,184	17897089816024

ESCORREDORES **TUBO BIG**

 **18** PRATOS
  **6** PORTA COPOS
  PORTA TALHERES PLÁSTICO



414-7 | Escorredor de Louças Cama Big Cromado c/ Porta Copos e Porta Talheres de Plástico cx. c/ 8 pçs



 **16** PRATOS

 **5** PORTA COPOS

 PORTA TALHERES PLÁSTICO



060-6 | Escorredor de Louças Duplo Big Cromado c/ Porta Copos e Porta Talheres de Plástico cx. c/ 6 pçs



Código	EAN	Descrição	Dimensão (cm)	Peso (kg)	Qt. cx. master	Dimensão cx. master (cm)	Peso cx. master (kg)	Cubagem cx. master (m³)	DUN 14
060-6	7897089800606	ESCORR.LOUÇAS P/16 PRATOS DUPL0 BIG CROM.C/PCOPOS E PTALH.PRETO	42,5 X 30 X 28,5	1,026	6	60 X 42 X 73	7,290	0,184	67897089800608
414-7	7897089804147	ESCORR.LOUÇAS P/18 PRATOS CAMA BIG CROM.C/PCOPOS E PTALH.PRETO	58 X 38 X 16	0,958	8	60 X 42 X 73	8,655	0,184	87897089804143

*Comprimento x Largura x Altura

IR PARA O ÍNDICE

ESCORREDORES TUBO

12 PRATOS

5 PORTA COPOS

680-6 | Escorredor de Louças Duplex Fixo c/ 5 Porta Copos Cromado cx. c/ 6 pçs

040-8 | Escorredor de Louças Duplex Fixo c/ 5 Porta Copos Cromado cx. c/ 6 pçs



10 PRATOS

ESPAÇO P/ TALHERES



027-9 | Escorredor Cama Luxo Cromado cx. c/ 12 pçs



1606-5 | Escorredor de Louças Cama Tubo Black cx. c/ 10pçs

12 PRATOS

5 PORTA COPOS



819-0 | Escorredor de Louças Cama Tubo Cromado cx. c/ 10pçs

Código	EAN	Descrição	Dimensão (cm)	Peso (kg)	Qt. cx. master	Dimensão cx. master (cm)	Peso cx. master (kg)	Cubagem cx. master (m³)	DUN 14
027-9	7897089800279	ESCORR. LOUÇAS CAMA LUXO CROMADO	46 X 37 X 16	0,612	12	60 X 42 X 73	8,320	0,184	57897089800274
040-8	7897089800408	ESCORR. DUPLO 12 PRATOS C/ 5 P. COPOS CROM.	41 X 25 X 26	0,648	6	60 X 42 X 73	4,938	0,184	67897089800400
680-6	7897089806806	ESCORR. DUPLO 12 PRATOS C/ 5 P. COPOS CROM.	41 X 26 X 26	0,648	6	60 X 42 X 73	4,938	0,184	17897089806803
819-0	7897089808190	ESCORR. LOUÇAS CAMA TUBO CROMADO	41 X 36,5 X 14	0,616	10	60 X 42 X 73	7,160	0,184	17897089808197
1606-5	7897089816065	ESCORR. LOUÇAS CAMA TUBO BLACK	41 X 36,5 X 14	0,616	10	60 X 42 X 73	7,16	0,184	17897089816062

ESCORREDORES **DUPLEX DESMONTÁVEIS**



12 PRATOS

194-8 | Escorredor de Louças Duplex Desm. Cromado
cx. c/ 12 pçs



12 PRATOS

643-1 | Escorredor Duplex Desmontável Black cx. c/ 12 pçs



069-9 | Escorredor de Louças p/ 8 Pratos Duplo Desmontável Cromado cx. c/ 14 pçs



8 PRATOS

Código	EAN	Descrição	Dimensão (cm)	Peso (kg)	Qt. cx. master	Dimensão cx. master (cm)	Peso cx. master (kg)	Cubagem cx. master (m³)	DUN 14
069-9	7897089800699	ESCORR. LOUÇAS P/ 8 PRATOS DUPLO DESM. CROMADO	27 X 24,5 X 26	0,634	14	53 X 37,5 X 40,5	9,395	0,080	17897089800696
194-8	7897089801948	ESCORR. LOUÇAS DUPLO DESMONTÁVEL CROMADO	38 X 24,5 X 26	0,760	12	53 X 37,5 X 40,5	9,645	0,080	67897089801940
643-1	7897089806431	ESCORR. LOUÇAS DUPLO DESMANTÁVEL BLACK	43 X 24,5 X 26	0,712	12	53 X 37,5 X 40,5	9,110	0,080	17897089806438

*Comprimento x Largura x Altura

IR PARA O ÍNDICE

ESCORREDORES **DUPLEX DESMONTÁVEIS**

 **12** PRATOS



PORTA TALHERES
PLÁSTICO PRETO

702-5 | c/ Porta Talheres Verde cx. c/ 12 pçs

703-2 | c/ Porta Talheres Laranja cx. c/ 12 pçs

704-9 | c/ Porta Talheres Branco cx. c/ 12 pçs



011-8 | Escorredor Duplex Cromado Desm. c/ Porta Talheres Preto cx. c/ 12 pçs



 **12** PRATOS



PORTA TALHERES



137-5 | Escorredor de Louças Duplo Desmontável c/ Pé Plástico Preto cx. c/ 10 pçs



Código	EAN	Descrição	Dimensão (cm)	Peso (kg)	Qt. cx. master	Dimensão cx. master (cm)	Peso cx. master (kg)	Cubagem cx. master (m³)	DUN 14
011-8	7897089800118	ESCORR. LOUÇAS DUPLO DESM. CROMADO C/ P.TALH. PRETO	43 X 24,5 X 26	0,782	12	53 X 37,5 X 40,5	9,980	0,080	67897089800110
137-5	7897089801375	ESCORR. LOUÇAS DUPLO DESM. C/ PÉS PLÁSTICO PRETO	49 X 23 X 27	0,642	10	64 X 51 X 41	7,735	0,134	17897089801372
702-5	7897089807025	ESCORR. LOUÇAS DUPLO DESM. CROMADO C/ P.TALH. VERDE	43 X 24,5 X 26	0,774	12	53 X 37,5 X 40,5	9,855	0,080	17897089807022
703-2	7897089807032	ESCORR. LOUÇAS DUPLO DESM. CROMADO C/ P.TALH. LARANJA	43 X 24,5 X 26	0,774	12	53 X 37,5 X 40,5	9,855	0,080	17897089807039
704-9	7897089807049	ESCORR. LOUÇAS DUPLO DESM. CROMADO C/ P.TALH. BRANCO	43 X 24,5 X 26	0,774	12	53 X 37,5 X 40,5	9,855	0,080	17897089807046

ESCORREDORES CAMA PRÁTICO

 **12** PRATOS

 **5** PORTA COPOS

 **PORTA TALHERES PLÁSTICO**



388-1 | Escorredor de Louças Cama "Prático" Cromado c/ Porta Copos e Porta Talheres Plástico Preto cx. c/ 10 pçs

- 470-3 | c/ Porta Talheres Branco cx. c/ 10 pçs
- 692-9 | c/ Porta Talheres Verde cx. c/ 10 pçs
- 693-6 | c/ Porta Talheres Laranja cx. c/ 10 pçs

solapa



 **12** PRATOS

 **5** PORTA COPOS

 **PORTA TALHERES PLÁSTICO**

solapa



1575-4 | Escorredor de Louças Cama "Prático" Black c/ Porta Copos e Porta Talheres Plástico Preto cx. c/ 10 pçs

Código	EAN	Descrição	Dimensão (cm)	Peso (kg)	Qt. cx. master	Dimensão cx. master (cm)	Peso cx. master (kg)	Cubagem cx. master (m³)	DUN 14
388-1	7897089803881	ESCORR.LOUÇAS CAMA PRATICO CROM.C/P.COPOS E P.TALH.PRETO	48 X 28 X 16	0,514	10	60 X 42 X 58	6,200	0,146	57897089803886
470-3	7897089804703	ESCORR.LOUÇAS CAMA PRATICO CROM.C/P.COPOS E P.TALH. BRANCO	48 X 28 X 16	0,514	10	60 X 42 X 58	6,200	0,146	17897089804700
692-9	7897089806929	ESCORR.LOUÇAS CAMA PRATICO CROM.C/P.COPOS E P.TALH. VERDE	48 X 28 X 16	0,520	10	60 X 42 X 58	6,230	0,146	17897089806926
693-6	7897089806936	ESCORR.LOUÇAS CAMA PRATICO CROM.C/P.COPOS E P.TALH. LARANJA	48 X 28 X 16	0,520	10	60 X 42 X 58	6,230	0,146	17897089806933
1575-4	7897089815754	ESCORR. LOUÇAS CAMA PRATICO BLACK C/P.COPOS E P.TALH. PRETO	48 X 28 X 16	0,514	10	60 X 42 X 58	6,200	0,146	17897089815751

*Comprimento x Largura x Altura

IR PARA O ÍNDICE

ESCORREDORES DIVERSOS



965-4 | Escorredor de Louças Cama "Max" Cromado c/ Porta Copos e Porta Talheres Preto cx. c/ 12 pçs

12 PRATOS

5 PORTA COPOS

PORTA TALHERES PLÁSTICO

solapa



755-1 | Escorredor de Louças Cama "Max" Black c/ Porta Copos e Porta Talheres Preto cx. c/ 12 pçs



539-7 | Aramado p/ Louças Cama Arame Cromado cx. c/ 15 pçs

10 PRATOS

4 PORTA COPOS

ESPAÇO P/ TALHERES

solapa



665-3 | Aramado p/ Louças Cama Arame Black cx. c/ 15 pçs



705-6 | Escorredor/Organizador de Pratos Cromado cx. c/ 6 pçs

10 PRATOS

solapa



1567-9 | Escorredor/Organizador de Pratos Black cx. c/ 6 pçs

Código	EAN	Descrição	Dimensão (cm)	Peso (kg)	Qt. cx. master	Dimensão cx. master (cm)	Peso cx. master (kg)	Cubagem cx. master (m³)	DUN 14
539-7	7897089805397	ARAMADO P/ LOUÇAS CAMA ARAME CROMADO	34,5 X 34,5 X 13	0,452	15	64,5 X 37,5 X 37,5	7,355	0,091	17897089805394
665-3	7897089806653	ARAMADO P/ LOUÇAS CAMA ARAME BLACK	34,5 X 34,5 X 13	0,456	15	64,5 X 37,5 X 37,5	7,560	0,091	17897089806650
705-6	7897089807056	ESCORREDOR ORGANIZADOR DE PRATOS CROMADO	12 X 34 X 23	0,219	6	47 X 20 X 28,5	1,544	0,027	17897089807053
755-1	7897089807551	ESCORR. LOUÇAS CAMA MAX BLACK C/P.COPOS E C/P.TALH. PRETO	48,5 X 34,5 X 14	0,518	12	60 X 42 X 58	7,205	0,146	17897089807558
965-4	7897089809654	ESCORR. LOUÇAS CAMA MAX CROM. C/ P.COPOS E C/ P.TALH. PRETO	48,5 X 34,5 X 14	0,518	12	60 X 42 X 58	7,205	0,146	17897089809651
1567-9	7897089815679	ESCORREDOR ORGANIZADOR DE PRATOS BLACK	12 X 34 X 23	0,219	6	47 X 20 X 28,5	1,544	0,027	17897089815676



MM PASSERINI LTDA.
Rua Giestas, 1.154 • CEP: 03147-001
Vl. Bela • São Paulo/SP
Indústria Brasileira
CNPJ: 64.660.491/0001-80
SAC (11) 2341 3880 / 2341 0096
www.mmpasserini.com.br